



Ravaglioli

COMPANY WITH
QUALITY SYSTEM
CERTIFIED BY DNV GL
= ISO 9001 =

SOLLEVATORI ELETTROIDRAULICI A FORBICE 

ELECTRO-HYDRAULIC SCISSOR LIFTS 

ELEKTROHYDRAULISCHE SCHERENHEBEBÜHNEN 

RAV

635

640

650

660

SERIES

From 3500 to 4200, 5000 and 6000 kg

rustehnika.ru

rustehnika.ru

rustehnika.ru



PLATFORMS

4600 x 615 mm

5500 x 650 mm

New



Sollevatori con pedane piane
Lifts with flat platforms
Hebebühnen mit flachen Fahrschienen

1

SERIE 635 / 3500 kg
SERIE 640 / 4200 kg

Sollevatori con pedane di grandi dimensioni e struttura portante studiata per la massima rigidità e stabilità in esercizio.

Lifts with large size platforms and sturdy structure assuring maximum rigidity and working stability.

Hebebühnen mit grossdimensionierten Fahrschienen und für hervorragende Steifigkeit und Betriebsstabilität konstruierte Tragstruktur.

SERIE 650 / 5000 kg
SERIE 660 / 6000 kg

La lunghezza delle pedane di 5,5 m garantisce il sollevamento ottimale di veicoli commerciali di notevoli dimensioni (es: furgoni a passo lungo)

Long platforms (5,5 m) ensure optimum lifting of light and medium commercial vehicles and long-wheelbase vans.

Die Länge der Fahrschienen beträgt 5,5 m und gewährleistet ein optimales Heben von Lieferfahrzeugen mit großen Abmessungen (z.B. Lieferwagen mit langem Achsstand).

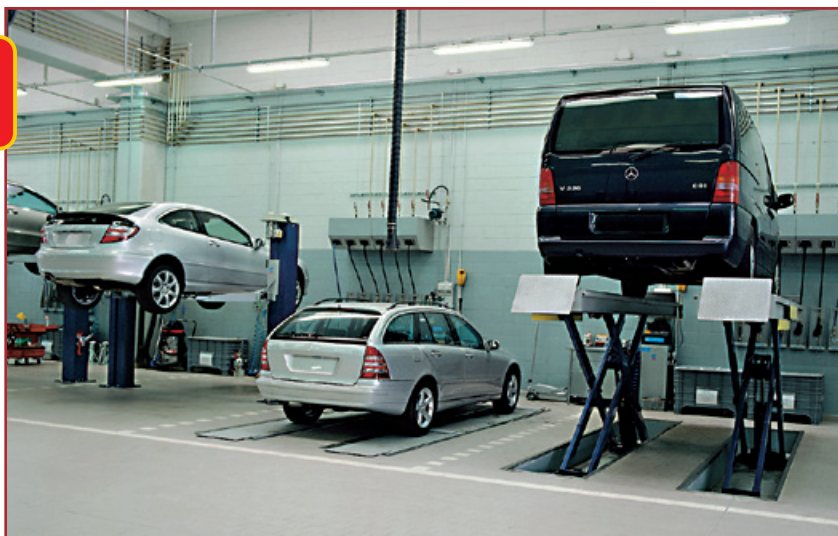

rustehnika.ru

rustehnika.ru

rustehnika.ru

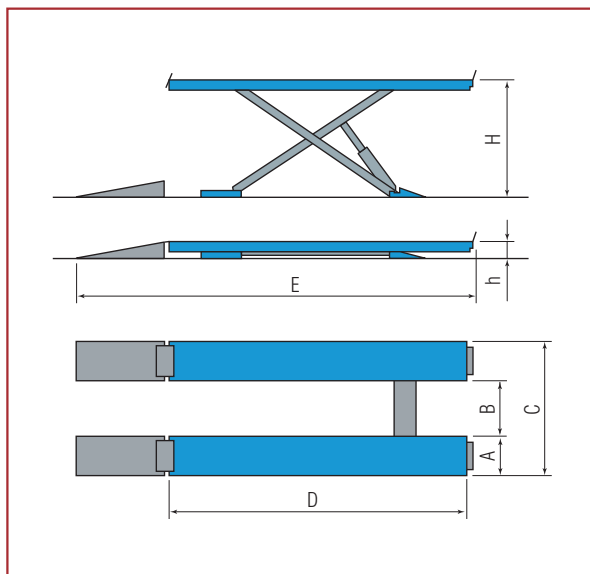

	Portata Capacity Tragfähigkeit	Motore Motor Motor	A	B	C	D	E	h	H
	kg	kW	mm	mm	mm	mm	mm	mm	mm
RAV 635.1	3500	2,6	615	870	2100	4600	6110	265	1850
RAV 635.1 I							x		
RAV 635.1 SI		3,5					6130	295	1880
RAV 635.1 ISI							x		
RAV 640.1	4200	2,6	615	870	2100	4600	6110	265	1850
RAV 640.1 I							x		
RAV 640.1 SI		3,5					6130	295	1880
RAV 640.1 ISI							x		
RAV 650.1.55	5000	2,6	650	900	2200	5500	7015	265	1850
RAV 650.1.55I							x		
RAV 650.1.55SI		3,5					7015	295	1880
RAV 650.1.55ISI							x		
RAV 660.1.55	6000	2,6	650	900	2200	5500	7015	270	1850
RAV 660.1.55I							x		
RAV 660.1.55SI		3,5					7015	300	1880
RAV 660.1.55ISI							x		

rustehnika.ru

rustehnika.ru

rustehnika.ru

Sollevatori per misurazione assetto ruote
Wheel alignment lifts
Hebebühnen für die Achsvermessung

2



Pedane per assetto totale, con sedi anteriori per piatti rotanti e piani oscillanti posteriori.
Platforms for total wheel alignment, with front turning plates locations and rear slip plates.
 Fahrschienen für die gesamte Achsvermessung, vorne mit Sitzen für Drehteller und hinten mit Schiebleplatten.

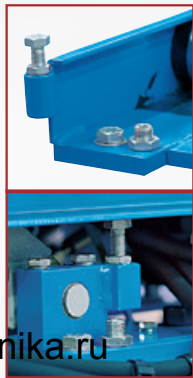

Basi con dispositivi di livellamento per facilitare le operazioni di installazione.
Base plates with levelling system to ease installation
 Grundrahmen mit Nivellier Vorrichtungen für ein einfacheres Aufstellen.

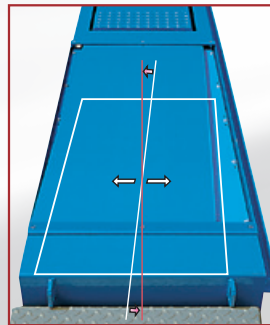

Piattaforme oscillanti con bloccaggio pneumatico in posizione centrata e movimenti di oscillazione angolare e trasversale in entrambe le direzioni.
Rear slip plates with pneumatic locking in true position, angular and transversal movements in both directions.
 Schiebleplatten mit pneumatischer Arretierung in zentrierter Position sowie Winkel- und Querverschiebung in beiden Richtungen.

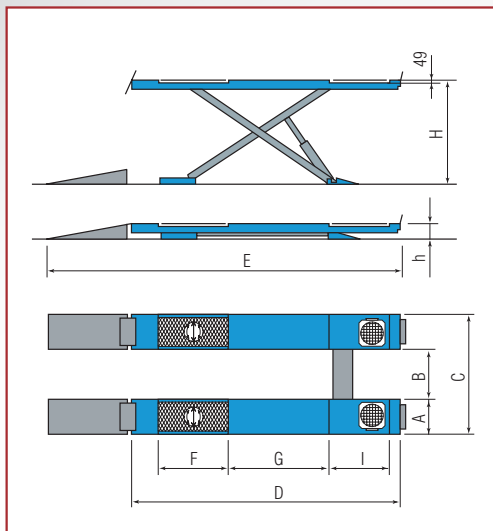

	Portata Capacity Tragfähigkeit	Motore Motor Motor	A	B	C	D	E	F	G	I	h	H
	kg	kW	mm	mm	mm	mm	mm	mm	mm	mm	mm	mm
RAV 635.2	3500	2,6	615	870	2100	4600	6110	1740	1764	825	265	1850
RAV 635.2 I							x				2085	
RAV 635.2 SI		3,5					6130				295	1880
RAV 635.2 ISI							x				2115	
RAV 640.2	4200	2,6	615	870	2100	4600	6110	1740	1764	825	265	1850
RAV 640.2 I							x				2085	
RAV 640.2 SI		3,5					6130				295	1880
RAV 640.2 ISI							x				2115	
RAV 650.2.55	5000	2,6	650	900	2200	5500	7015	1780	1745	1525	265	1850
RAV 650.2.55I							x				2070	
RAV 650.2.55SI		3,5					7015				295	1880
RAV 650.2.55ISI							x				2100	
RAV 660.2.55	6000	2,6	650	900	2200	5500	7015	1780	1745	1525	270	1850
RAV 660.2.55I							x				2070	
RAV 660.2.55SI		3,5					7015				300	1880
RAV 660.2.55ISI							x				2100	

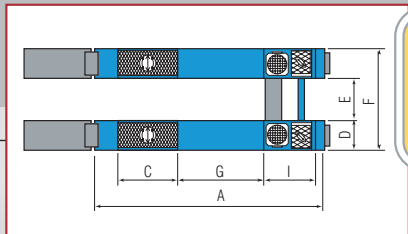

Sollevatori per allineamento con provagiochi
Alignment lifts with built in play detector
Achsmessbühnen mit Gelenkspieltestern

3 **5**



	Portata Capacity Tragfähigkeit	A	B	C	D	E	F	G	I	h	H
	kg	mm	mm	mm	mm	mm	mm	mm	mm	mm	mm
RAV 640.3.46	4200	4600	6110	1280	615	870	2100	1764	900	265	1850
RAV 640.3.46 I			x								2085
RAV 640.3.46 SI			6130								1880
RAV 640.3.46 ISI			x								2115
RAV 640.5.55	4200	5500	7015	1780	650	900	2200	1745	1525	265	1850
RAV 640.5.55I			x								2070
RAV 640.5.55SI			7015								1880
RAV 640.5.55ISI			x								2100
RAV 650.5.55	5000	5500	7015	1780	650	900	2200	1745	1525	265	1850
RAV 650.5.55I			x								2070
RAV 650.5.55SI			7015								1880
RAV 650.5.55ISI			x								2100
RAV 660.5.55	6000	5500	7015	1780	650	900	2200	1745	1525	270	1850
RAV 660.5.55I			x								2070
RAV 660.5.55SI			7015								1880
RAV 660.5.55ISI			x								2100

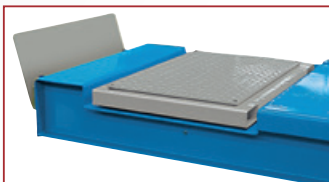
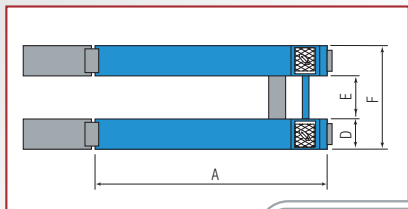

rustehnika.ru

4 **6**

Sollevatori con provagiochi
Lifts with built in play detector
Hebebühnen mit Gelenkspieltestern

	Portata Capacity Tragfähigkeit	A	B	D	E	F	h	H
	kg	mm	mm				mm	mm
RAV 635.4	3500	4600	6110	615	870	2100	265	1850
RAV 635.4 I			x					2085
RAV 635.4 SI			6130					1880
RAV 635.4 ISI			x					2115
RAV 640.4.46	4200	4600	6110	615	870	2100	265	1850
RAV 640.4.46 I			x					2085
RAV 640.4.46 SI			6130					1880
RAV 640.4.46 ISI			x					2115
RAV 640.6.55	4200	5500	7015	650	900	2200	265	1850
RAV 640.6.55I			x					2070
RAV 640.6.55SI			7015					1880
RAV 640.6.55ISI			x					2100
RAV 650.6.55	5000	5500	7015	650	900	2200	265	1850
RAV 650.6.55I			x					2070
RAV 650.6.55SI			7015					1880
RAV 650.6.55ISI			x					2100
RAV 660.6.55	6000	5500	7015	650	900	2200	270	1850
RAV 660.6.55I			x					2070
RAV 660.6.55SI			7015					1880
RAV 660.6.55ISI			x					2100

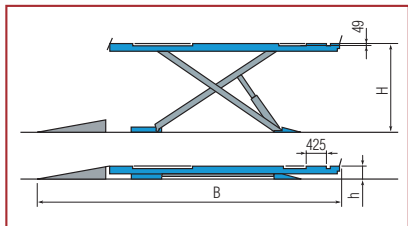

Piastre con superficie bugnata per evitare lo slittamento piastra-ruota.

Plate with indented surface to prevent plate-wheel sliding.

Platten mit Bossenoberfläche um das Platte-Rad-Rutschen zu vermeiden.

RAV 635.4 } Provagiochi a 4 movimenti
 RAV 640.3 } 4 movement play detector
 RAV 640.4 } 4 Bewegungen Gelenkspieltester

RAV 650.5 } Provagiochi a 8+4 movimenti
 RAV 650.6 } 8+4 movement play detector
 8+4 Bewegungen Gelenkspieltester

Motore - Motor - Motor **2,6 kW**

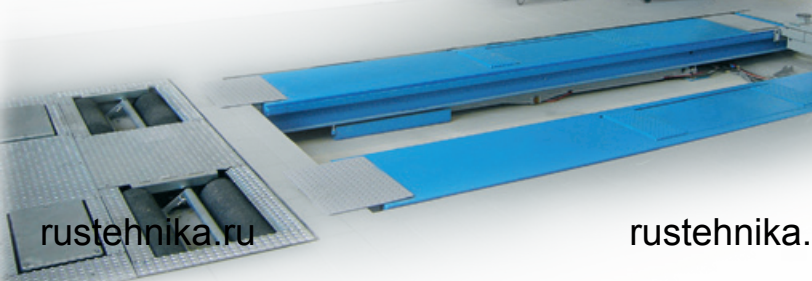



La soluzione ottimale per l'ambiente di lavoro razionale:

- minimi ingombri a sollevatore alzato
- pavimento completamente libero nella posizione tutto basso.

Assenza dei collegamenti meccanici tra le pedane (massima operatività nella zona di lavoro).

The best solution for a rational workshop:

- space saving when lift is raised
- obstacle free floor space when lift is fully lowered.

No cross rails or torsion bars between lifting platforms (for maximum accessibility in the working area).

Die optimale Lösung für den rationellen Arbeitsraum:

- minimale Ausmasse bei hochgefahrener Hebebühne
- vollständig freier Fussboden in der tiefsten Position.

Keine mechanischen Verbindungen zwischen den Fahrschienen (rundum frei).



rustehnika.ru

rustehnika.ru



Ponte omologato CE, comandi in bassa tensione.

CE approved lift with low voltage controls.

CE-geprüft, Niederspannungssteuerkreis.



rustehnika.ru

Dispositivo di segnalazione acustica nella parte terminale del movimento di discesa.

Audible alarm during the final lowering phase.

Akustikmelder im untersten Bereich der Absenkbewegung.

Perni di articolazione con boccole autolubrificanti non richiedenti manutenzione.

All pivot points made with self lubricating bushings for long life.

Gelenkbolzen mit selbstschmierenden Büchsen die keiner Wartung bedürfen.

Dispositivo di appoggio meccanico ad inserimento automatico e disinserimento pneumatico, a garanzia della massima sicurezza in fase di stazionamento.

Mechanical locking device with automatic engagement and pneumatic release, ensuring maximum safety when lift is in standing position.

Mechanische Stützvorrichtung mit automatischer Einschaltung und pneumatischer Ausschaltung, um eine maximale Sicherheit im aufgehobenen Zustand zu garantieren.

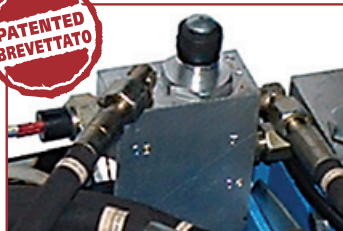

Sincronizzazione idraulica dei movimenti delle pedane indipendentemente dalla ripartizione del carico, con dispositivo di autoregolazione brevettato.

Hydraulic levelling system by means of a patented synchronisation device assures constantly level lifting platforms regardless of weight distribution.

Hydraulische Gleichlaufregelung der beiden Fahrschienen, unabhängig von der Lastverteilung, mit patentierter Selbstausgleichsrichtung.

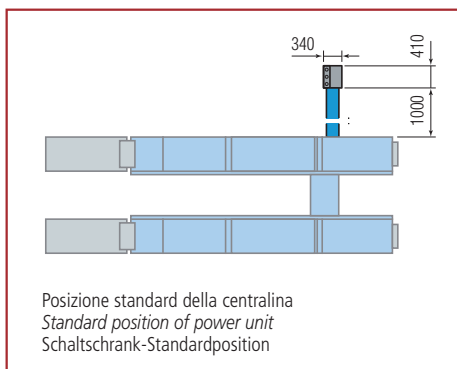

Versioni con sollevatore integrato
Versions with wheel free lift
Versionen mit integriertem Radfreiheber

Versioni SI
SI models
SI - Ausführungen

	Portata SI SI capacity SI-Tragfähigkeit	A	B	C
	kg	mm	mm	mm
SERIE 635 SI	3500	2000	1390	500
SERIE 640 SI				
SERIE 640.55SI	4000	2100	490	
SERIE 650.55SI				
SERIE 660.55SI				

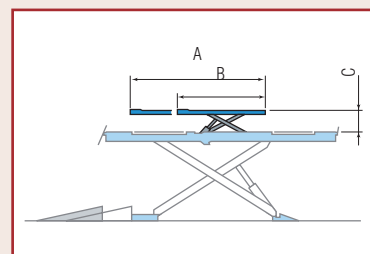

Versioni incassate Recessed versions Unterflurausführungen

Tutti i sollevatori possono essere forniti anche in versione incassata.

All can be supplied for recessed installation.

Alle Hebebühnen können auch in Unterflur-Version geliefert werden.

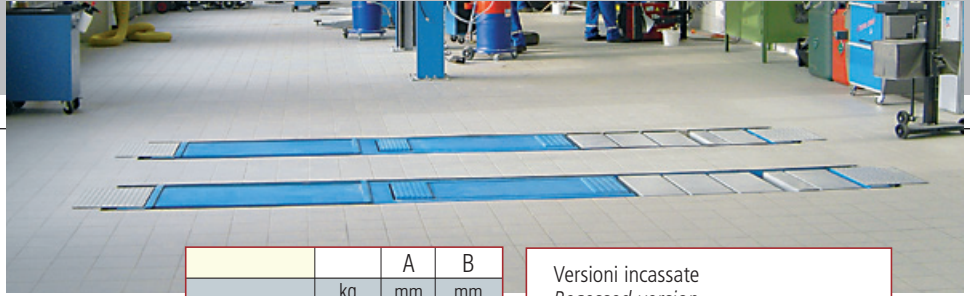

	kg	A mm	B mm
SERIE 635 I	3500	1805	2085
SERIE 635 ISI			2115
SERIE 640 I	4200		2085
SERIE 640 ISI			2115
SERIE 650 I	5000		2070
SERIE 650 ISI			2100
SERIE 660 I	6000	2070	
SERIE 660 ISI		2100	

Versioni incassate
Recessed version
Unterflurausführungen

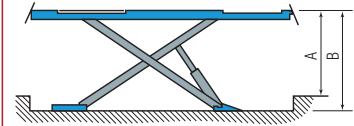

OPTIONS

Vedere documentazione specifica - See special technical specifications - Siehe spezifische Unterlagen.

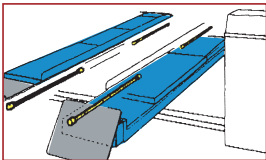

VAR650A7

Impianto di illuminazione
Lighting kit
Beleuchtung



S640A1

S650A1
S650LA2
S650LA3
Spessori di riempimento per sedi piatti rotanti
Spacers for turn table housing
Distanzstücke für Drehteller ausparungen



S640A1 (→ S640A1 standard) S650LA3 (→ S650LA2 standard)

Serie di spessori per la chiusura totale della posizione dei piatti rotanti

Set of spacers to completely close turntable recesses
rustehnika.ru
Drehtellerabdeckungen

rustehnika.ru



S611A4

Carter centralina
Power unit cover
Schaltkastenabdeckung



Traverse
Jacking beams
Achsheber

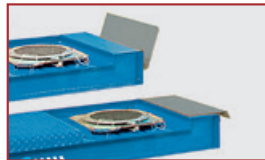

S110A7 (2 x kit)

Piatti rotanti per assetto.
Turntables for wheel alignment.
Drehteller für Achsvermessung.

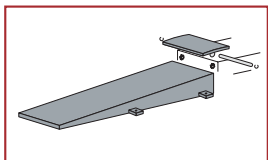

S601A4 (→ serie RAV 635/640/650+SI)

Rampe lunghe - Lunghezza 1900 mm.
Longer run-up ramps - 1900 mm long.
Längere Auffahrampen - 1900 mm lang.



Comando a distanza per tutti i modelli.
Remote control hand set for all models.
Kabelfernsteuerung für alle Ausführungen.

SI

OPTIONS

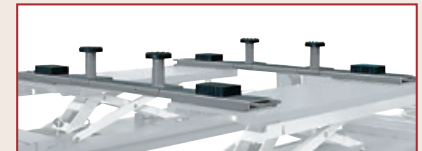

S505A2 (2 x kit)

Traverse
Indispensabili per il sollevamento in sicurezza a ruote libere di fuoristrada e veicoli particolari con punti di sollevamento su pianale ravvicinati.

Cross members
To provide safe wheel free lifting of vehicles with narrow lifting points.

Querstreben
Für ein sicheres Anheben von Geländewägen und Sonderfahrzeugen mit Radfreihebern an aneinander angenäherten Hebekpunkten auf der Hebebühne.

Set tamponi / Set of pads / Satz Klötze
(4 x kit)

S505A1 H= 200 mm

S505A5 H= 120 mm

S505A9 H= 60 mm

S505A6 H= 40 mm

S505A7 H= 20 mm

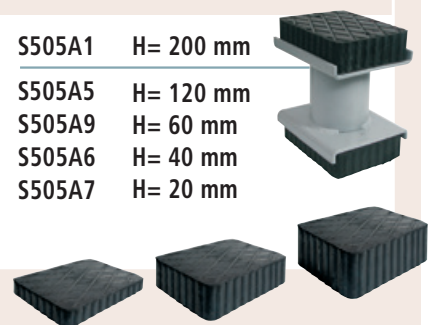

Ravaglioli S.p.A.
via 1° maggio 3
Fraz. Pontecchio M.
40037 Sasso Marconi (Bo) - Italia
Tel. +39 - 051 - 6781511
Fax +39 - 051 - 846349
rav@ravaglioli.com
www.ravaglioli.com

RAV France
4, Rue Longue Raie
ZAC de la Tremblaie
91220 Le Plessis Pâté
Tel. 01.60.86.88.16
Fax 01.60.86.82.04
rav@ravfrance.fr

Ravaglioli Deutschland
Kirchenpoint 22
85354 Freising
Tel. 08165-646956
Fax 08165-646958
ravd@ravaglioli.com

RAV Equipment UK LTD
Prince Albert House
20 King Street
Maidenhead, SL6 1DT
Tel. +39 - 0516781522
rav@ravaglioli.com

RAV en Belgique
Nederlandstalig
Tel. 0498-162016
Fax 016-781025
Zone Francophone
Tel. 0498-163016
Fax +32 78 055 030

RAV Equipos España S.L.U.
Avenida Europa 17
Pol. Ind. de Constanti
Tarragona 43120
Tel. 977 524525
Fax 977 524532
ravequipos@ravaglioli.e.telefonica.net

DRD11D (11)

Le caratteristiche tecniche e gli allestimenti presentati in questo prospetto possono subire variazioni. Le immagini riprodotte non sono vincolanti.
Technical data and composition presented in this catalogue may vary. Pictures reproduced are only indicative.
Die techn. Daten und die Ausrüstungen, die in diesem Prospekt enthalten sind, können Änderungen erfahren. Deshalb sind die Abbildungen unverbindlich.