

Instructions manual
Manuel d'instructions
Gebrauchsanleitung
Manuale d'uso
Manual de instrucciones
Manual de instruções
Instrukcja Obsługi
Gebruikershandleiding

[MANUK4Q.OB0]

INDEX

INDEX	3
INTRODUCTION	6
<i>CARE OF THE MANUAL</i>	6
CONDITIONS OF WARRANTY	7
GENERAL INFORMATION	8
END-OF-LIFE	9
<i>BATTERY DISPOSAL</i>	9
SAFETY RULES	10
<i>REFRIGERANT AND LUBRICANT - PERSONAL PROTECTIVE EQUIPMENT AND PRECAUTIONS</i>	11
<i>HOSES CONNECTION</i>	11
<i>PRECAUTIONS FOR HANDLING AND USE OF R134a FLUIDS</i>	12
<i>RULES FOR WORKING WITH R1234yf FLUIDS</i>	12
PRINCIPLES OF OPERATION	15
SETUP	16
<i>Release refrigerant scale:</i>	16
<i>Lock refrigerant scale:</i>	16
RECOVERY MACHINE	17
<i>PLASTIC COVER</i>	17
<i>CONTROL PANEL</i>	17
<i>FUNCTION SELECTOR KEYBOARD</i>	19
<i>DISPLAY ICONS</i>	20
<i>BASIC COMPONENTS</i>	22
<i>ALARMS</i>	27
<i>ERROR CODES</i>	28
PRELIMINARY OPERATIONS	31
AUTOMATIC PROCEDURE	33
<i>Edit VACUUM data:</i>	34
<i>Edit OIL data:</i>	34
<i>Edit UV data:</i>	34
<i>Edit GAS FILLING data:</i>	34
<i>Edit GAS FILLING mode:</i>	35
<i>START AUTOMATIC PROCEDURE:</i>	35
MANUAL PROCEDURE	40
<i>HIGH PRECISION RECOVERY</i>	40
<i>STANDARD RECOVERY</i>	42
<i>VACUUM</i>	43
<i>OIL+UV INJECTION</i>	45

Edit OIL data	45
Edit UV data	45
Edit GAS FILLING data	45
Edit GAS FILLING mode	46
START procedure	46
FILLING	49
Edit GAS FILLING data	49
Edit GAS FILLING mode	49
START procedure	49
FLUSHING HOSES ^(optional)	52
NITROGEN TEST ^(optional)	54
NITROGEN TEST (N ₂)	55
MIXTURE TEST (N ₂ +H ₂)	57
A/C SYSTEM FLUSHING ^(optional)	60
GAS ANALYZER ^(optional)	62
SANITIZER ^(optional)	63
DYNAMIC DIAGNOSIS ^(optional)	64
STATIC DIAGNOSIS ^(optional)	69
EXPRESS SERVICE	71
SETUP	72
LANGUAGE	72
OPTIONS	73
VACUUM SETTINGS	74
N₂ TEST SETTINGS	75
SETUP HEADER PRINT	76
INSERT OPERATOR NUMBER	77
COUNTERS	78
SET DATE / TIME	79
OIL SETTINGS	80
MAINTENANCE	81
CALIBRATION	82
BOTTLE CELL	83
OIL CELL	86
USED OIL CELL	87
BOTTLE PRESSURE	88
A/C PRESSURE	90
EVAPORATOR PRESSURE	92
TEMPERATURE	94
RESTORE CALIBRATION	95
EMPTYING HOSES	96
BOTTLE FILLING	97
CHANGE DRYER FILTER	99
A/C PRESSURES CHECK	104
AIR PURGE MANUAL	106
SERVICES ARCHIVE	107
SEARCH BY PLATE	107
SEARCH BY DATE	108
EXTRACT ARCHIVE	109

<i>CHANGE OIL/UV CONTAINER</i>	110
<i>VACUUM PUMP OIL CHANGE OIL</i>	111
<i>VACUUM PUMP</i>	112
M.1) OIL TOP-UP	112
M.2) OIL CHANGE	114
<i>FILLING THE RECHARGEABLE COLLAPSIBLE NEW OIL CONTAINER</i>	117
<i>FILLING THE RECHARGEABLE COLLAPSIBLE UV CONTAINER</i>	118
<i>REPLACE THE NEW OIL CARTRIDGE</i>	119
<i>REPLACE THE NEW UV CARTRIDGE</i>	120
<i>EMPTYING THE USED OIL CONTAINER</i>	121
<i>REPLACING THE PRINTER PAPER</i>	122
<i>DATA</i>	123

INTRODUCTION

This machine is a pressure unit as can be seen in the CE declaration of conformity and Data plate. The equipment supplied conforms to the Essential Safety Requirements according to Annex I of Directive 2014/68/UE (PED). Any work involving repairs, modifications, and/or changing pressurized components or parts make safe use of the equipment very risky. Any tasks done must be authorized by the Manufacturer.



This manual contains important information pertinent to operator safety. Read this manual through before beginning operation of the machine.

The manufacturer reserves the right to modify this manual and the machine itself with no prior notice. We therefore recommend checking any updates. This manual must accompany the machine in case of sale or other transfer.

Any repair, modification, or changing of components not formally agreed with and authorized by the manufacturer poses a risk of the conformity to Directive 2014/68/UE being nullified and makes this pressure equipment a significant risk. If not authorized in writing the Manufacturer considers the tasks indicated above to be tampering with the machine, which nullifies the initial declaration of conformity issued, and so they do not accept any direct responsibility.

Braze welding of parts that contribute to the pressure strength of the equipment and the parts directed attached to it was done by adequately qualified personnel, using adequate operating methods. Approval of the operating methods and personnel was entrusted to a competent outside party for category III pressure equipment, and any work on this equipment that involves the need to carry out braze welding must comply with the requirements laid down in annex 1 of Directive 2014/68/UE, or the Manufacturer. For the relevant information see the relevant information.

- The pressure equipment has been inspected and tested, complete with the safety accessories identified by the manufacturer as being of a direct discharge type with calibrated air pressure. Testing and inspection of the accessories is not necessary prior to starting up.
- The pressure equipment must be subjected to routine inspections and checks when operating, according to the relevant regulations and legal norms.

For the unit in question, it is hereby declared that a competent Authorized Body carried out their part of the final check according to annex I of point 3.2.3 of Directive 2014/68/UE as well as checking safety accessories and control devices in conformity to comma d) of art 5 of Ministerial Decree 329 of 01/12/2004.

List of the critical components in terms of PED safety DIR 2014/68/UE

Condenser, dehydrator filters, distributor, refrigerant storage bottle, airtight compressor, safety pressure switch, pressure transducers, and safety valves.

The operator has to check/substitute the PED critical components before their respective end of life (according to national law)

CARE OF THE MANUAL

This manual must be kept for the entire life of the machine and protected against humidity and excessive heat. Take care not to damage this manual in any way during consultation.

CONDITIONS OF WARRANTY

Refer to CONDITIONS OF WARRANTY booklet supplied with the machine.

GENERAL INFORMATION

Machine model information are printed on the data plate (see Fig.1). Overall machine dimensions:

Height:	1100 mm	Width:	640 mm
Depth:	680 mm	Weight:	90 kg
Operating temperature	10/50°C	Storage temperature	-25/+50°C

Like any equipment with moving parts, the machine inevitably produces noise. The construction system, paneling, and special provisions adopted by the Manufacturer are such that during work the average noise level of the machine is not in excess of 64 dB (A).

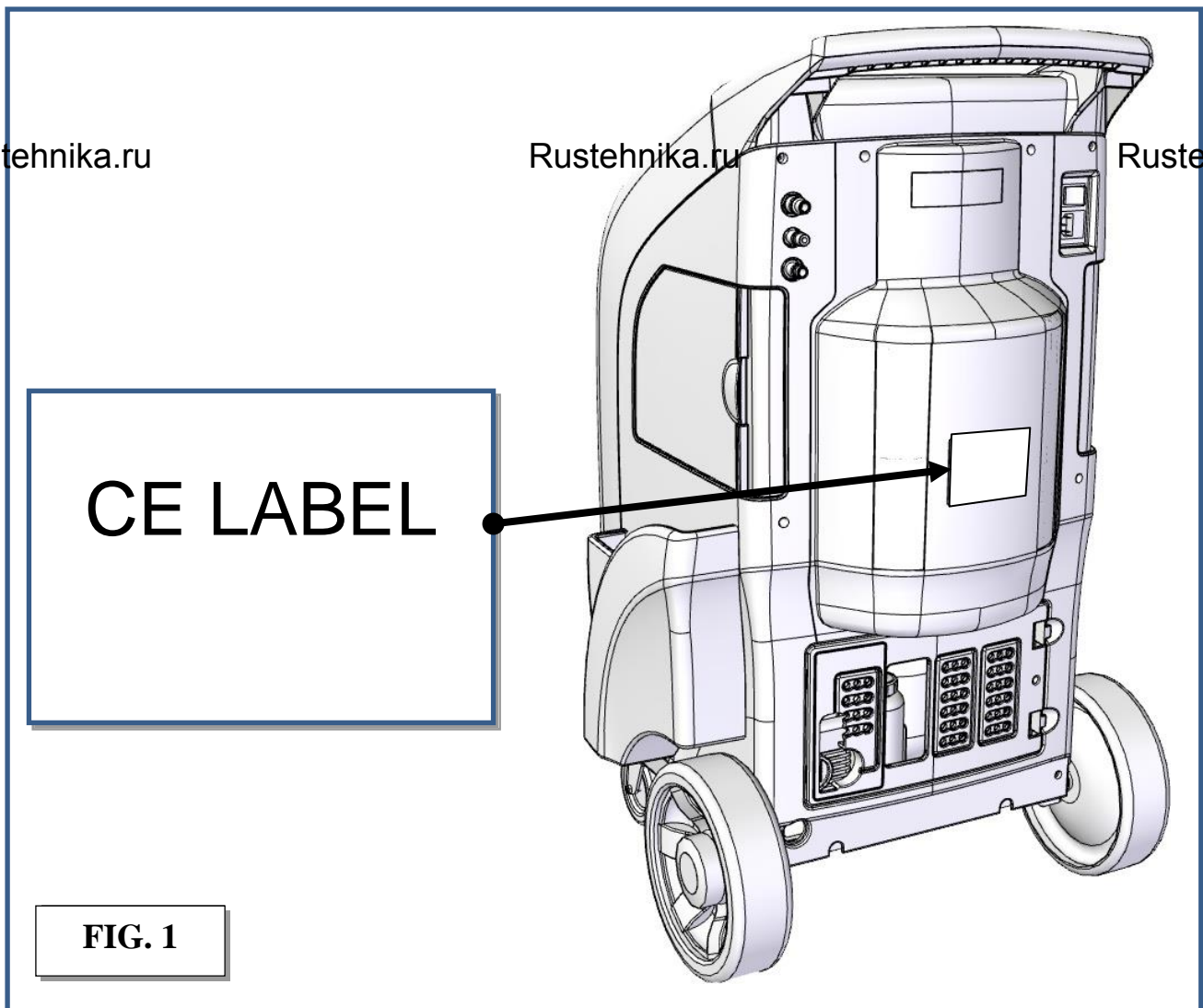

END-OF-LIFE

The symbol on the right indicates that in accordance with Directive 2012/19/UE the machine may not be disposed of as ordinary municipal waste but must be delivered to a specialized center for separation and disposal of WEEE (Waste Electrical and Electronic Equipment) or be returned to the dealer in case of purchase of a new machine. Current legislation provides severe sanctions in the case of disposal of WEEE into the environment. If improperly used or disposed of into the environment, electrical and electronic equipment can release substances dangerous for the environment and for human health.



BATTERY DISPOSAL

The machine uses an electronics card containing a Lithium battery (ref:1, Fig.2). When discharged, it must be removed by expert personnel trained in machine demolition.

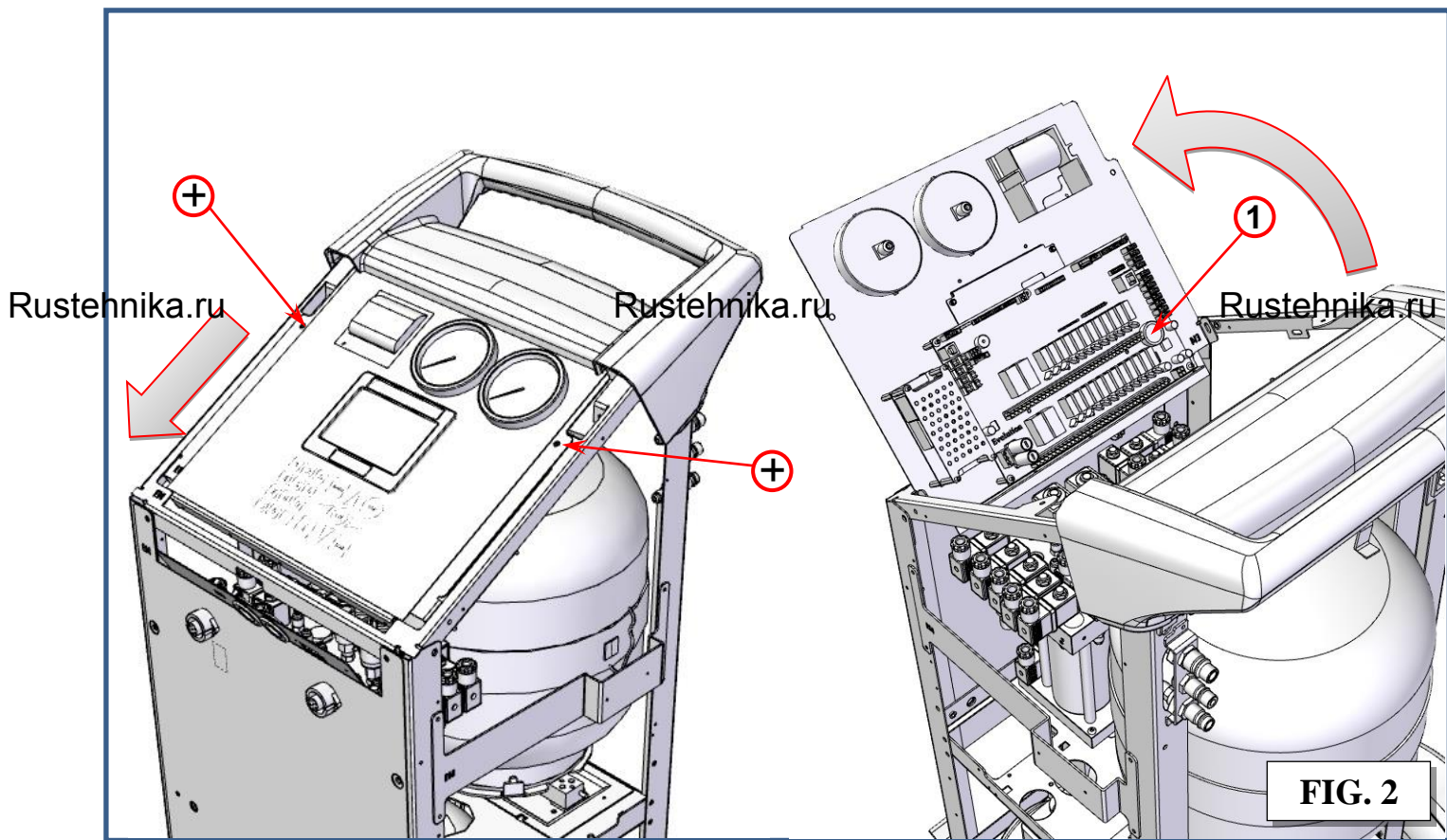

SAFETY RULES

This machine is a piece of equipment designed to recover R134a or R1234yf (depending on machine model) from air conditioning systems (A/C) for vehicles. The machine must be used by qualified personnel and can only be used correctly after having read this manual that also contains the basic safety rules listed below:

- **Wear gloves and safety glasses.**
- Do not expose to direct sunlight and rain.
- Before doing any task check the vehicle's operating and maintenance handbook to determine the type of refrigeration fluid used in the A/C system.
- No smoking in the vicinity of the machine and while working.

The ambient conditions for using the equipment are as follows:

- Temperature between +10 and +50°C.
- Pressure between 80 kPa (0,8 bar) and 110 kPa (1.1 bar).
- Air with normal oxygen content, generally 21% by volume.

Laying-up the machine: when not in use the machine must be stored in a specific place with the following characteristics:

1. The machine must be stored in a ventilated zone also during storage. It can be avoided that are pit near the machine.
2. There must be no sources of ignition such as heat sources, naked flames, sparks of mechanical origin (e.g. due to grinding), electrical material (especially the storage area for the machine is not to have any electrical power sockets that are less than 900 mm above floor level), stray electrical currents and cathode corrosion (check that the electrical distribution system conforms to the relevant legal provisions), static electricity (check the earth system for the premises' electricity distribution system), and lightning.

- Hose must be visually checked periodically, if they are damaged, or aged, substitute them.
- Use the machine away from heat sources, naked flames and/or sparks.
- Always make sure that when you switch off the engine the vehicle's ignition key is turned to the Fully Off position.
- Always connect the machine's piping using the RED rapid coupling to the high pressure branch of the A/C system.
- Always connect the machine's piping using the BLUE rapid coupling to the low pressure branch of the A/C system.



CAUTION: some car manufacturer on the fuel intake manifold install a connector identical to the A/C low pressure fitting.

DANGER: DO NOT connect the recovery station to this connection; you risk to recover petrol.

- Keep the connection pipes away from moving or rotating items or elements (cooling fan, alternator, etc.).
- Keep the connection pipes away from hot items or elements (engine exhaust pipes, radiator, etc.).
- Always fill the A/C system with the quantity of fluid recommended by the manufacturer. Never exceed this quantity.
- Always check the oil levels prior to each operation.
- Always keep the oil at the correct quantity.
- Before connecting the machine to the electrical system, check that the power supply voltage and frequency are the same as the values indicated on the CE plate.

The bottle must be filled to 80% of its maximum capacity to leave a plenum chamber for the gas to absorb any increases in pressure.

- Never touch the taps on the inner bottle.
- Throw the oil taken out of the A/C system and the vacuum pump into the relevant containers for spent oils.
- Change the filters at the intervals laid down, using only filters recommended by the manufacturer.
- Only use the oils recommended by the manufacturer.
- Only use the UV approved by the manufacturer.
- Never confuse the vacuum pump oil with the oil for the air-conditioning systems.

Failure to comply with any of these safety rules leads to any form of guarantee for the machine being rendered null and void.

Machine is provided with class III safety valve, in case of malfunctioning it can create an external sack of flammable gas; keep the machine in well ventilated area.

WARNING: R134a and/or R1234yf vapor/gas refrigerant are heavier than air and may thicken on the floor or inside the cavity/pits and cause choking by reducing oxygen available for breathing.

At high temperatures the refrigerant decomposes releasing toxic and caustic substances, hazardous for the operator and the environment. Avoid inhalation of the refrigerants and A/C system oils .

Exposure can irritate the eyes and airways.

WARNING: The machine must be connected to a socket with effective ground

WARNING: This is a class "A" product. In a domestic environment this product may cause radio interference. In such cases, the user may be required to take adequate measures.

REFRIGERANT AND LUBRICANT - PERSONAL PROTECTIVE EQUIPMENT AND PRECAUTIONS

Handled with caution refrigerants and pressure vessels, since otherwise there could be health risks .

The operator must wear safety glasses, gloves and suitable clothing to work , contact with refrigerant may cause blindness (eyes), and other physical damage (frostbite) to the operator. Avoid contact with the skin, the low boiling temperature (about -26°C for R134a and about -30°C for R1234yf) can cause cold burns.

Do not change the setting of the relevant devices for safety, do not remove the seals of the safety valves and control systems . Do not use external tanks or other storage containers that are not approved, or without safety valves.

During the functioning, the air vents and ventilation equipment must not be blocked or covered



HOSES CONNECTION

Hoses may contain refrigerant under pressure. Before substitute the quick coupler verify the corresponding pressure in the service hoses (gauge).

The machine is equipped with the following safety devices:

	<p>SAFETY PRESSURE: stops the compressor in case of excessive pressure</p> <p>SAFETY VALVE: opens when the pressure inside the system reaches a</p>
--	---

	level of pressure above the estimated limits. MAIN SWITCH: allows the machine's turnoff by sectioning of the power line. Prescribing however disconnection from the mains plug of the power cord before servicing
	IT IS NOT ALLOWED ANY KIND OF TAMPERING OF THE SAFETY DEVICES MENTIONED ABOVE

PRECAUTIONS FOR HANDLING AND USE OF R134a FLUIDS

Refrigerant fluids expand to the gaseous state in standard environmental conditions. In order that they may be shipped and used they must be compressed into suitable bottles. We therefore recommend observing all the general precautions applicable to handling of pressurized containers. In the case of R134a in particular, we suggest the following special precautions. Avoid inhaling highly concentrated vapors even for short periods of time, since such vapors can cause loss of consciousness or death. R134a is not flammable, but if the vapor is exposed to open flames or incandescent surfaces it may undergo thermal decomposition and form acid substances. The acrid and pungent odor of these products of decomposition is sufficient to signal their presence. We therefore recommend avoiding use of R134a near open flames and incandescent elements. There exists no evidence of risks deriving from transdermal absorption of R134a. Nevertheless, due to the low boiling point of the liquid, it is advisable to wear protective garments such as to ensure that no jets of liquid or gas can come into contact with the skin. The use of goggles to avoid contact with the eyes is especially recommended, since the refrigerant liquid or gas can cause freezing of the ocular fluids. Moreover, we strongly advise users to avoid dispersing the R134a refrigerant fluid utilized in the machine since it is a substance that contributes to raising the temperature of the planet, with a global warming potential(GWP) of 1300.

RULES FOR WORKING WITH R1234yf FLUIDS

Under ambient conditions refrigerant fluids are gases. In order to be able to transport and use them they must be compressed in specific bottles. The precautions for pressure vessels must therefore be applied.

In particular, for R1234yf be careful of the following situations:

- Inhalation of vapours at very high concentrations, even for short periods of time, must be avoided as it can cause unconsciousness and sudden death.
- R1234yf is flammable and if the vapour is exposed to naked flames or red hot surfaces it can undergo thermal decomposition with the formation of acid products. The acrid, pungent odour of these products of decomposition is sufficient to warn of their presence. Avoid finding yourself in the conditions just mentioned.
- There is no proof of risks resulting from the absorption of R1234yf through the skin, however, due to its low boiling point it is advisable to wear protective clothing that can prevent any liquid sprayed or vapour reaching the skin and especially the eyes, where they could cause the eye fluids to congeal.
- We also recommend no dispersing the R1234yf refrigerant fluid used in the machine, because it is a substance that contributes to heating the planet, with a global warming potential (GWP) of 4.

ANY USE THAT DIFFERS FROM THAT JUST DESCRIBED IS NOT ALLOWED BY THE MANUFACTURER.

Uses not allowed

This machine may not be used for tasks not envisaged or to handle products other than those envisaged, or for uses other than those specified in paragraphs "Conditions of use envisaged".

The following are forbidden:

1. Using the machine with a constructive configuration that differs from that envisaged by the manufacturer.
2. Using the machine in places at risk of explosion and/or fire
3. Adding other systems and/or equipment not considered by the manufacturer in their working design.
4. Using the machine without the perimeter protection and/or the fixed and mobile guards tampered with or removed.
5. Connecting the machine to energy sources other than those envisaged by the manufacturer.
6. Using the commercial devices for a purpose other than that envisaged by the manufacturer.

Actions not allowed on the part of the operator

The operator tasked with operating, supervising, and maintaining the machine **must not:**

1. Use the machine if they have not been trained and informed beforehand as called for by the law on safety in the workplace
2. Fail to act as described in the operating instructions.
3. Allow unauthorized people to approach and/or use the machine.
4. Tamper with the moving and fixed guards that provide perimeter protection, thereby also exposing other operators and people to risks of a residual nature.
5. Remove or alter the safety signs (such as pictograms, warning signs, and others) on the machine.
6. Use the machine without having first read and understood the behavioral, operating and maintenance information contained in the operating instructions.
7. Leave the maneuvering keys on the electromechanical controls (selectors), pneumatic controls, and doors of the housings for electrical and electronic materials (electrical panels and derivation boxes).
8. Carry out the following operations as they pose residual risks:
 - Adjust the mechanical, pneumatic, or electrical parts on the machine while it is working.
 - Remove the mechanical, pneumatic, or electrical parts on the machine while it is working.
 - Remove the protective devices for mechanical, pneumatic, or electrical parts on the machine while it is working.
 - Allow the machine to run when the electrical panels are open.

These uses, that cannot be avoided by way of construction, must not be allowed.



WARNING

The employer (or safety manager) is obliged to see to it that the machine is not used in an improper manner, putting the health of the operator and people exposed first.

The operator is obliged to inform their employer (or the system safety manager) if there is a danger of improper use of the machine since, as an instructed person, the operator is responsible for the use that is to be made of the machine.

9. If service station fall down, or is hit, or in case of big leakage, or sounds of flowing gas:

- an internal damage could happen, also if externally the machine seems good, and it is still working;
- the machine must be taken outdoor or in a very ventilated place.
- No fire, no smoke, no workers, no cars nearby this service station.
- The service station must be fully tested by a trained technician before to be used again.

PRINCIPLES OF OPERATION

In a single series of operations, the machine permits recovering and recycling refrigerant fluids (R134a or R1234yf, depending on machine model) with no risk of releasing the fluids into the environment, and also permits purging the A/C system of humidity and deposits contained in the oil.

The machine is in fact equipped with a built-in evaporator/separator that removes oil and other impurities from the refrigerant fluid recovered from the A/C system and collects them in a container for that purpose.

The fluid is then filtered and returned perfectly recycled to the bottle installed on the machine.

The machine also permits running certain operational and seal tests on the A/C system.

SETUP

The machine is supplied fully assembled and tested.
Remove the protections under the refrigerant scales as follows:

Release refrigerant scale:

- In order to remove the protections under the refrigerant scale the screw (ref.1, Fig.3) has to be unscrewed until it full stops
- Connect the machine to the electrical supply and switch it on
- Check if the value of refrigerant scale is correct.

Lock refrigerant scale:

NOTE: in the event that the equipment has to be transported, the refrigerant bottle scale should be locked in place as follows:

1. Switch the machine on.
2. Tighten the screw (ref.1, Fig.3) until the display signals ZERO availability.

NOTE: Check that the oil containers are properly placed in their housing

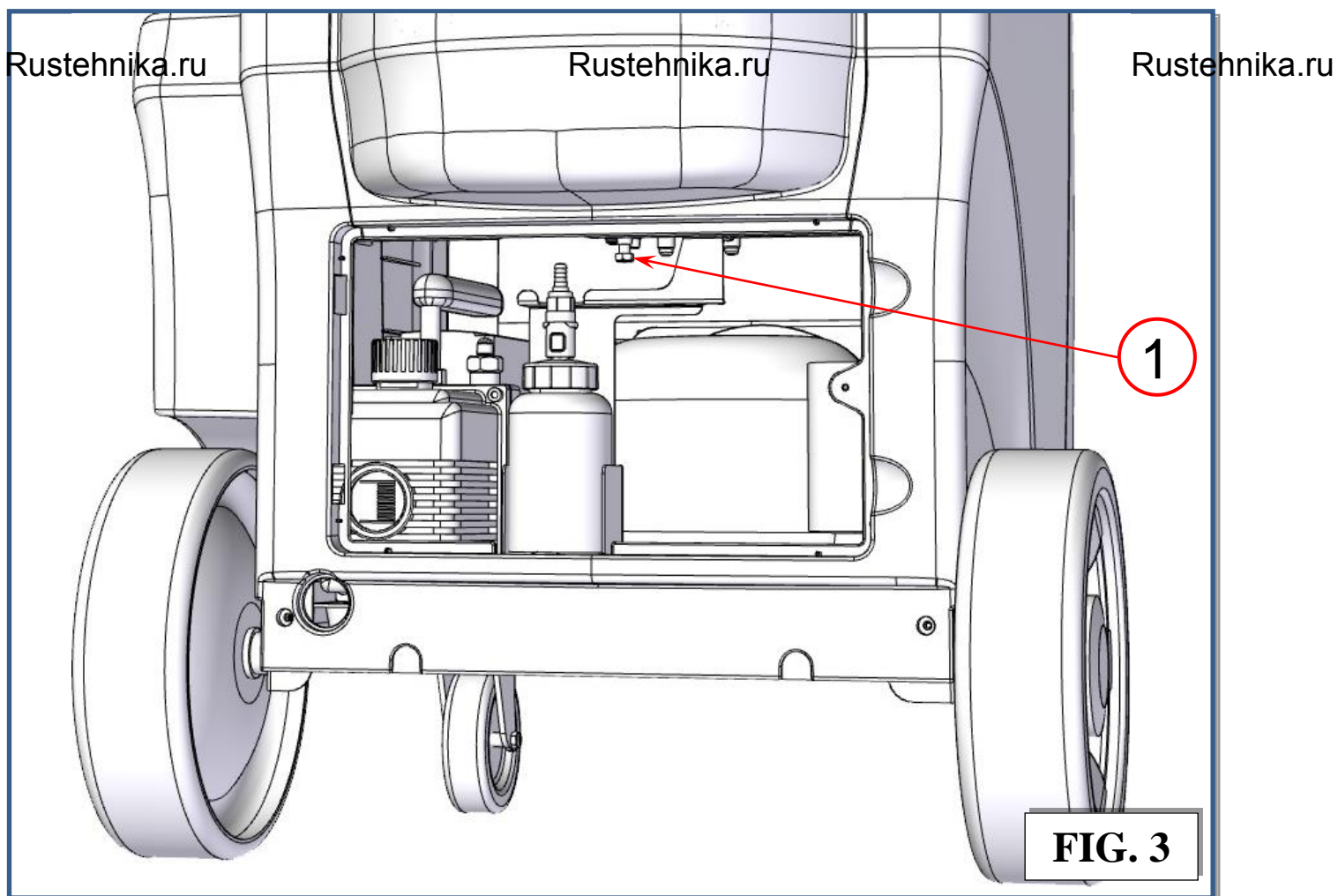

THE MACHINE

PLASTIC COVER

Refer to Fig.4 .

1. Front plastic cover
2. Rear plastic cover
3. Upper plastic cover

Disassembly: Screw off screws marked (+)

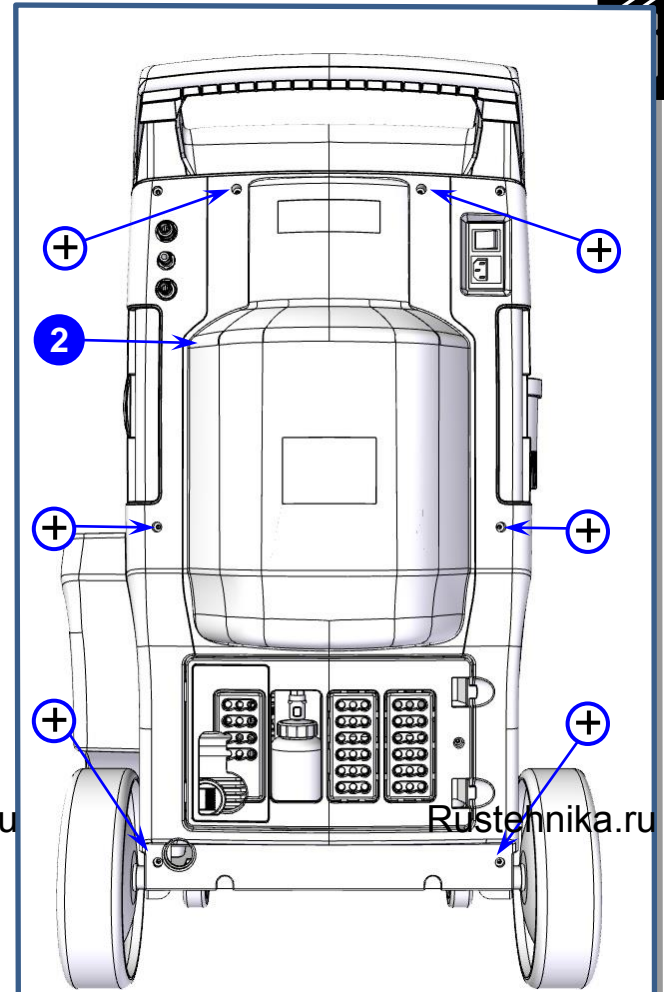

Rustehnika.ru

Rustehnika.ru

Rustehnika.ru

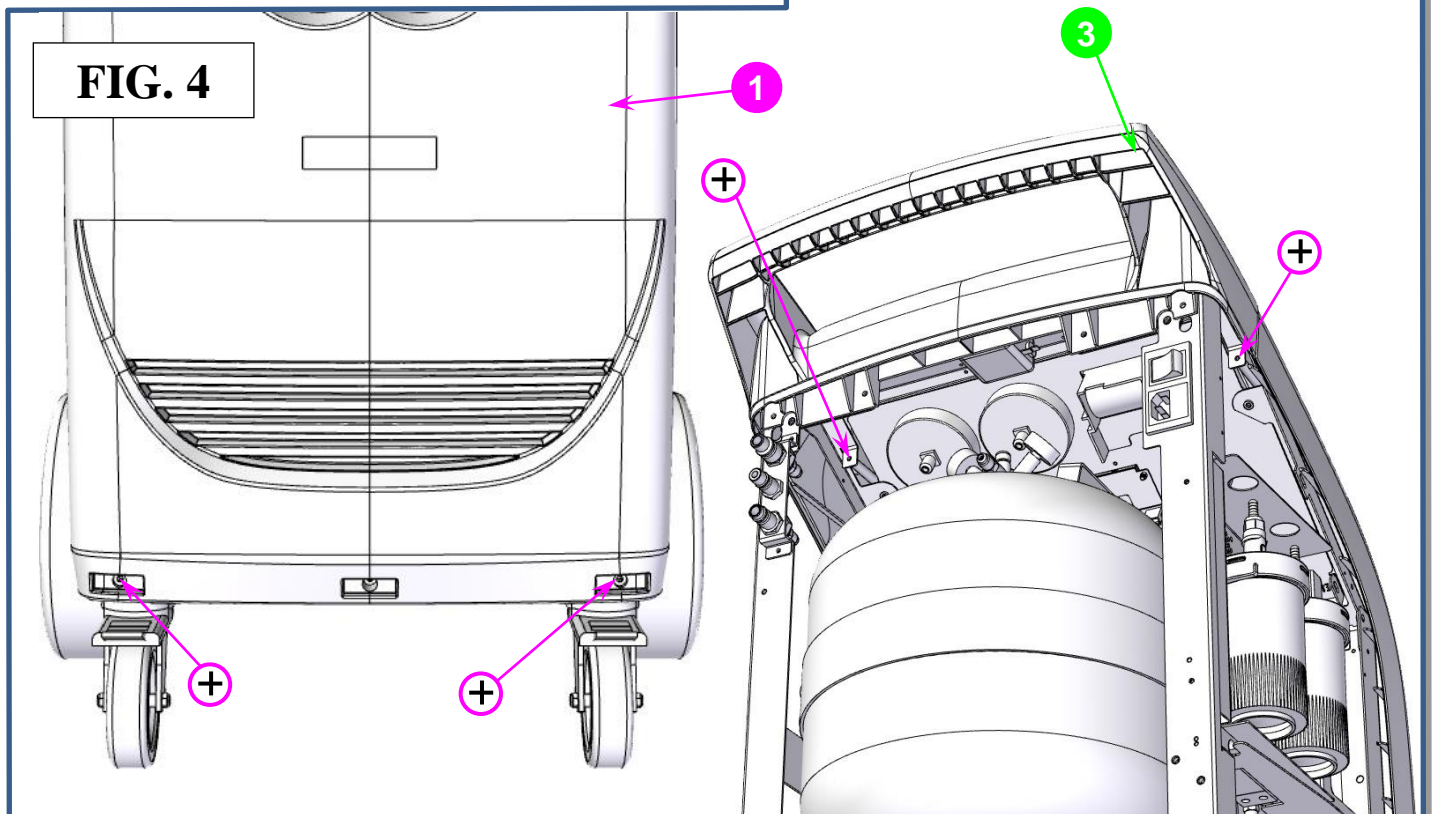

Rustehnika.ru

Rustehnika.ru

Rustehnika.ru

CONTROL PANEL

Refer to Fig.5 :

- 1) High pressure gauge
- 2) Low pressure gauge
- 3) Printer
- 4) 5" Graphic color display
- 5) Keypad

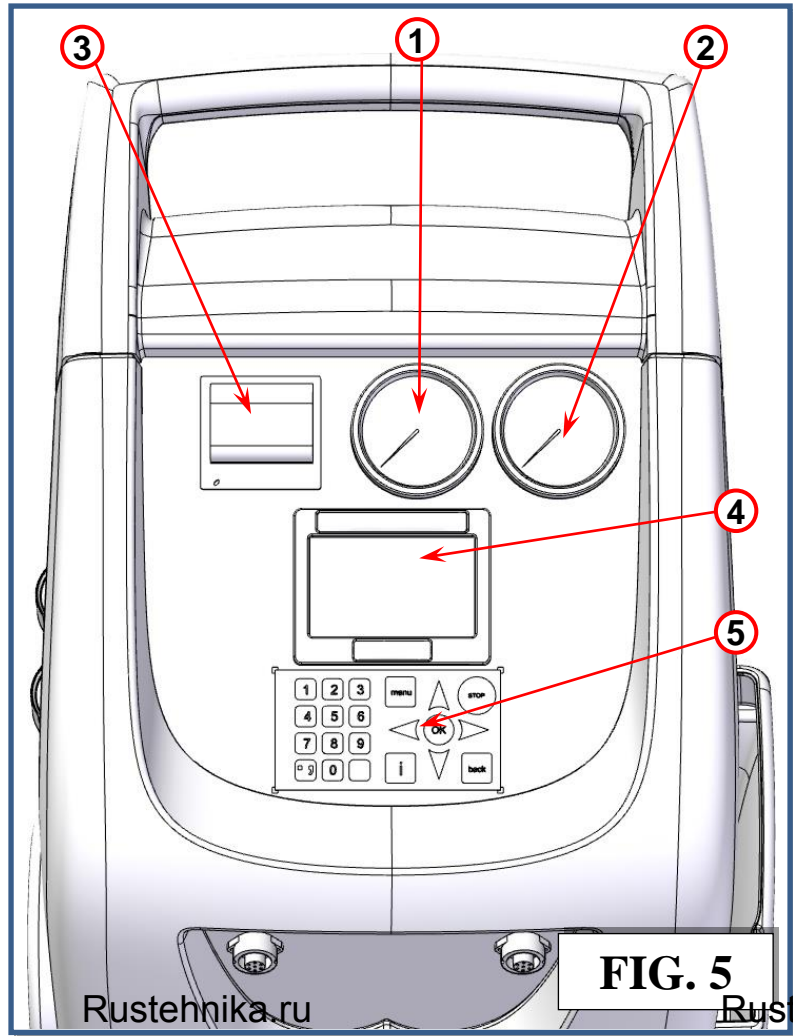

FIG. 5

FUNCTION SELECTOR KEYBOARD

Refer to Fig.6 :

STOP: interrupt and pause a operation (could be used in case of emergency)

OK: confirm or finish a procedure or operation shown on the display,

↓: used for scrolling down through menu items..

↑: used for scrolling up through menu items.

→: used for scrolling right through menu items.

←: used for scrolling left through menu items.

BACK: Return back to previous menu, or to exit from a procedure

i: visualize data information or restore default values when requested

MENU: to return to main menu

KEYPAD: Numerical keypad (includes an alphabet that is used similar to text messaging)

KEYPAD ⇐: key to cancel during the input of a parameter, value, plate or code

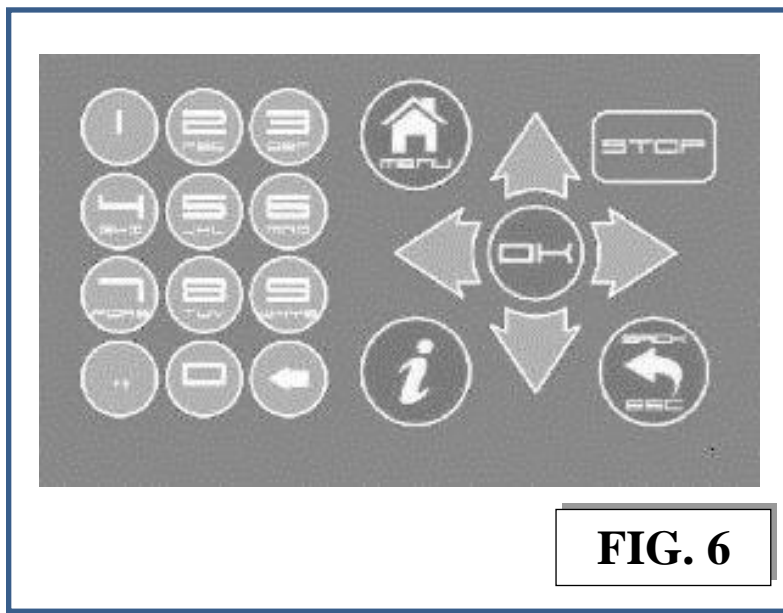



















FIG. 6

DISPLAY ICONS

ICON	DESCRIPTION	FUNCTION
	AUTOMATIC PROCEDURE	activates a menu that helps the user set up an automatic recover/vacuum/leak test/charge sequence.
	MANUAL PROCEDURE	activates a menu that helps the user to perform a manual operation:
	HIGH PRECISION RECOVERY	activates a menu that helps the user to perform an high precision recovery/recycling phase
	STANDARD RECOVERY	activates a menu that helps the user to perform a recovery/recycling phase (without SAE J-2788 or SAE J-2843 compliance)
	VACUUM	activates a menu that helps the user to perform a vacuum phase
	OIL / UV INJECTION	activates a menu that helps the user to perform a oil/uv injection followed by a gas filling phase
	GAS FILLING	activates a menu that helps the user to perform a gas filling phase
	DEVICES	activates devices menu
	FLUSHING HOSES	activates a menu that helps the user to perform a FLUSHING HOSES
	NITROGEN TEST	activates a menu that helps the user to perform a NITROGEN TEST
	A/C FLUSHING	activates a menu that helps the user to perform a A/C FLUSHING
	GAS ANALYZER	activates a menu that helps the user to perform a GAS ANALYSIS
	SANITIZER	activates a menu that helps the user to perform a A/C SYSTEM PURIFICATION
	DIAGNOSIS	activates a menu that helps the user to perform a A/C SYSTEM DIAGNOSIS

	EXPRESS SERVICE	activates a menu that helps the user set up a quick express recover/vacuum/leak test/charge sequence.
	SETUP	activates the setup menu of the service station
	MAINTENANCE	activates the maintenance menu of the service station
	DATA	activates a menu that contains all the information of the service station

BASIC COMPONENTS

Refer to Fig.7, Fig.8, Fig.9, Fig.10:

- a) USB port
- b) ---
- c) Main switch
- d) Fuse
- e) Socket for electrical supply plug
- f) Sanitizer socket (*)
- g) ---
- h) Ventilation grid
- i) UV cartridge (*)
- j) New oil cartridge (*)
- k) New Oil / UV scale
- l) Used oil scale
- m) Condenser + Fan
- n) Front swirling wheel
- o) Manifold
- p) Capsizable control panel
- q) Power supply filter
- r) Oil pump filling cap
- s) Refrigerant bottle lock knob
- t) Rear wheel
- u) New oil container (*)
- v) Used oil container
- w) UV container (*)
- x) External analyzer connection (*)
- y) 5V Power supply
- z) Dryer filter
- 1) Vacuum pump
- 2) Compressor
- 3) LP service hose outlet
- 4) HP service hose outlet
- 5) LP quick connection
- 6) HP quick connection
- 7) Handle
- 8) ----
- 9) Motherboard

(*) if installed, depending on machine model

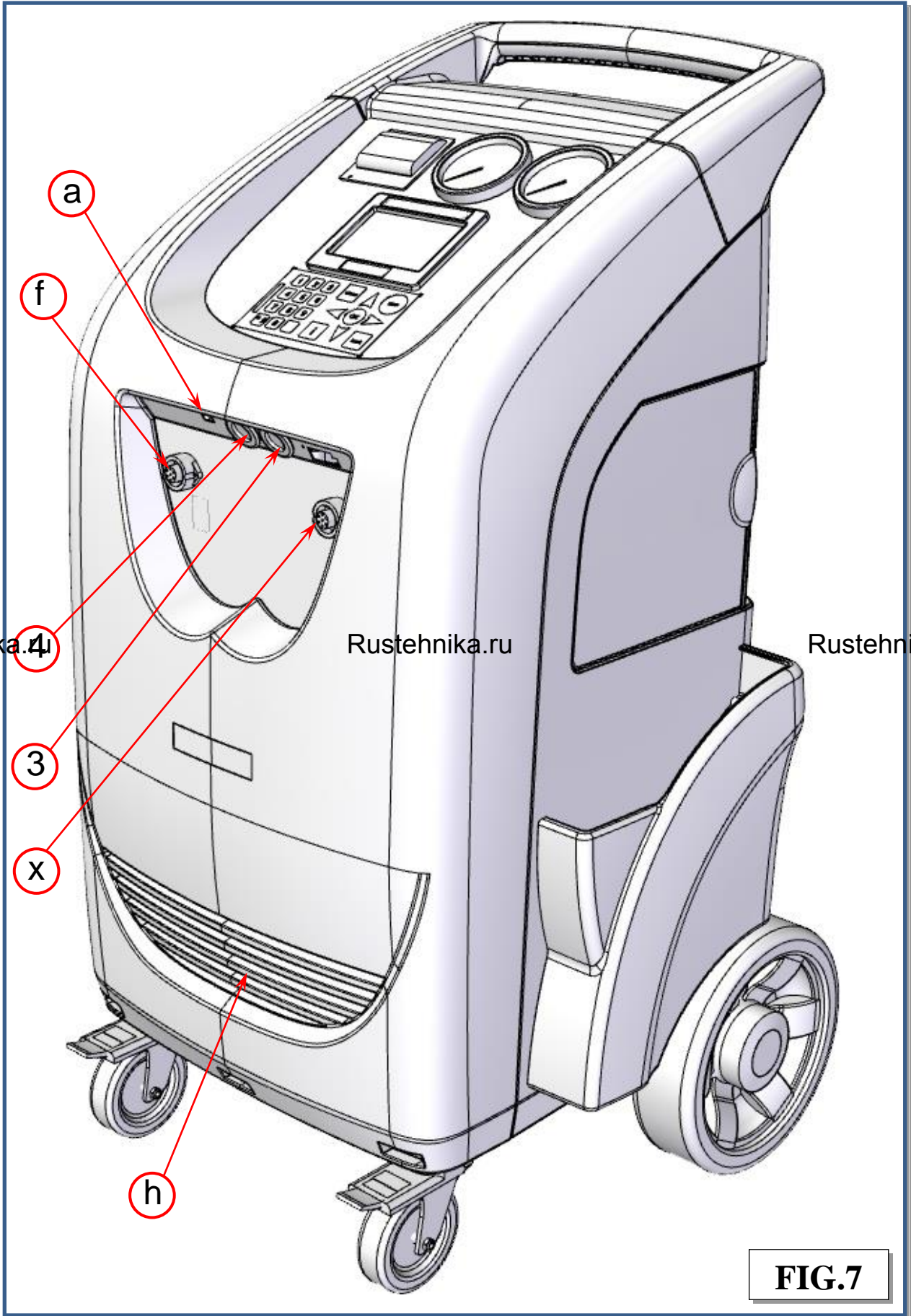
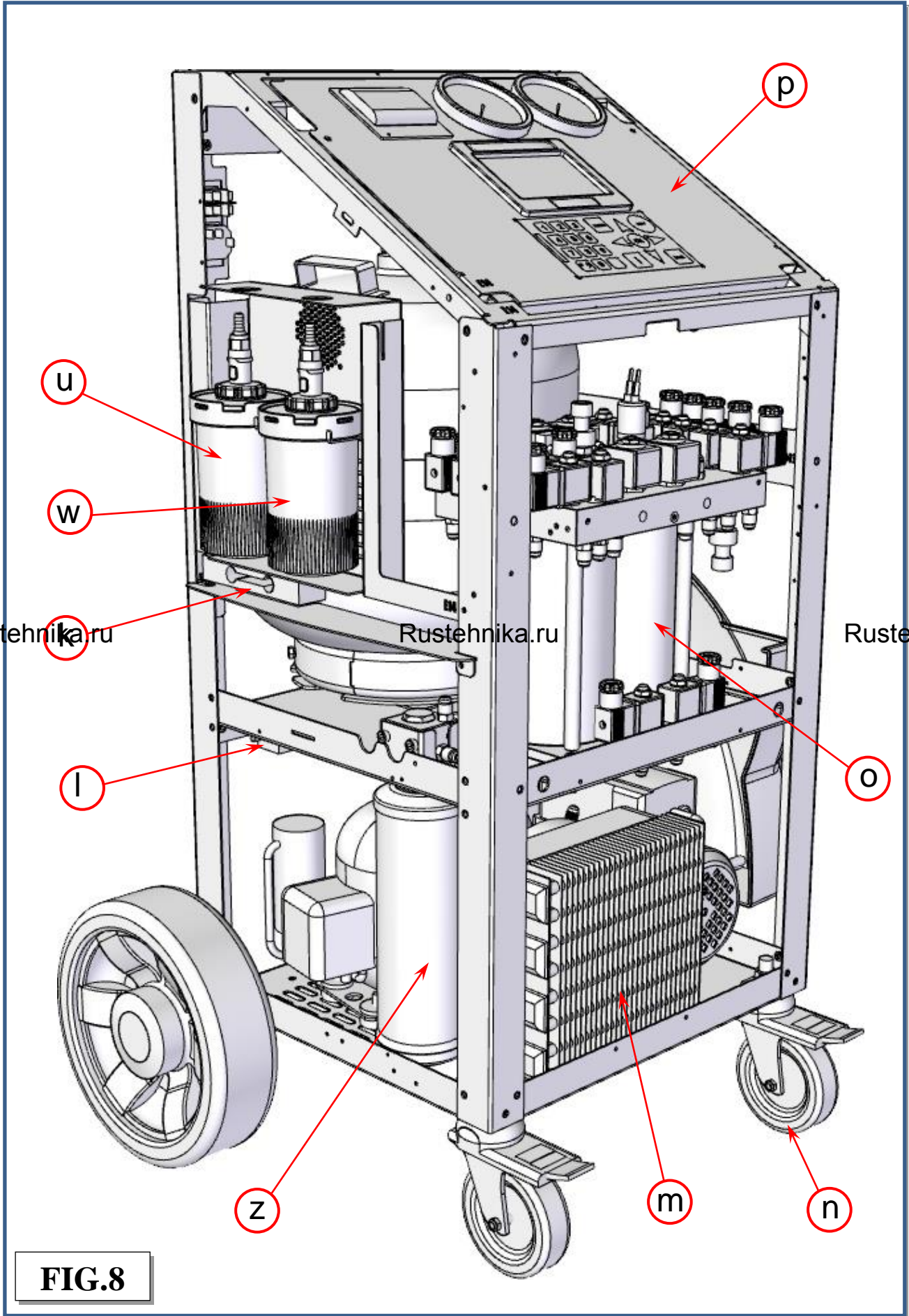
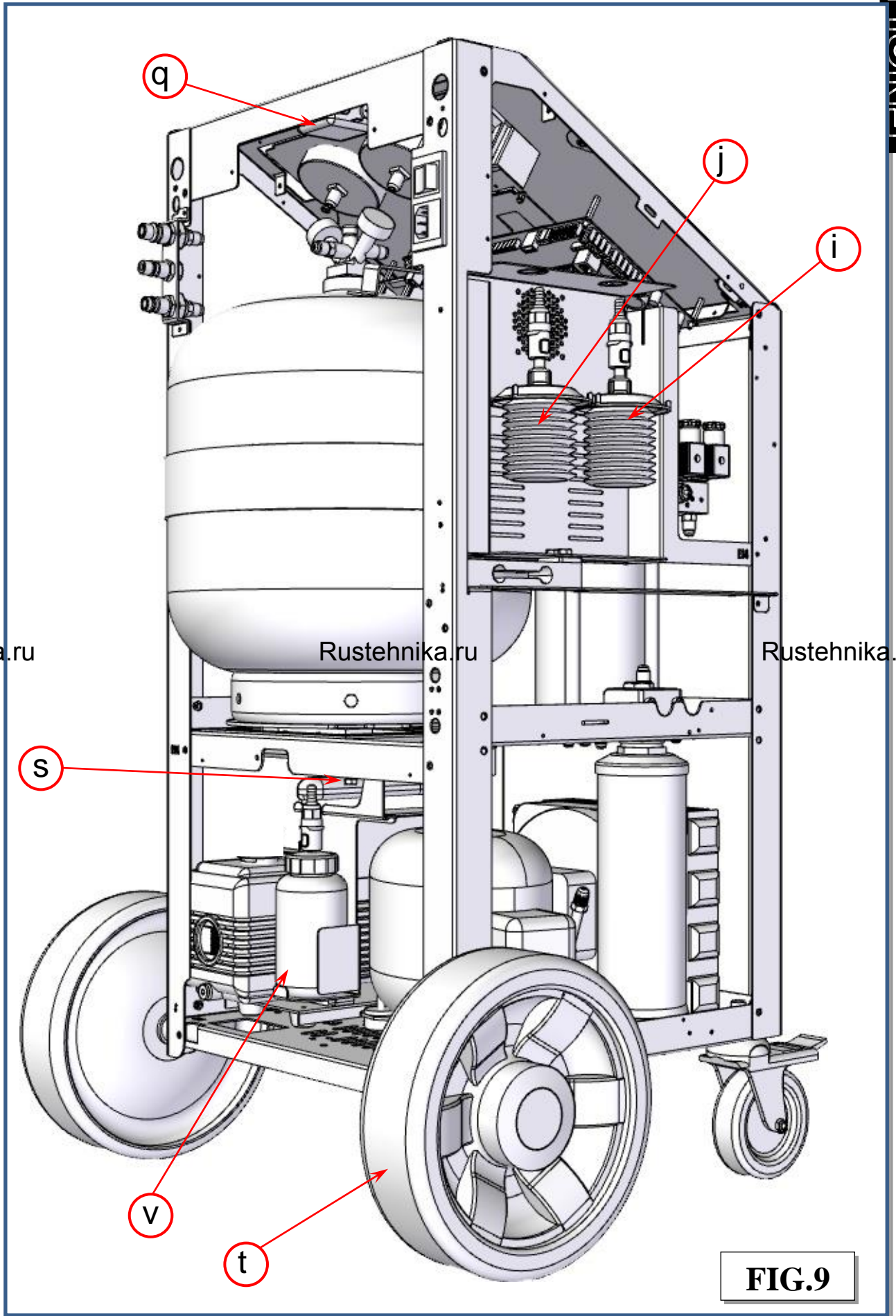

FIG.7





Rustehnika.ru

Rustehnika.ru

Rustehnika.ru

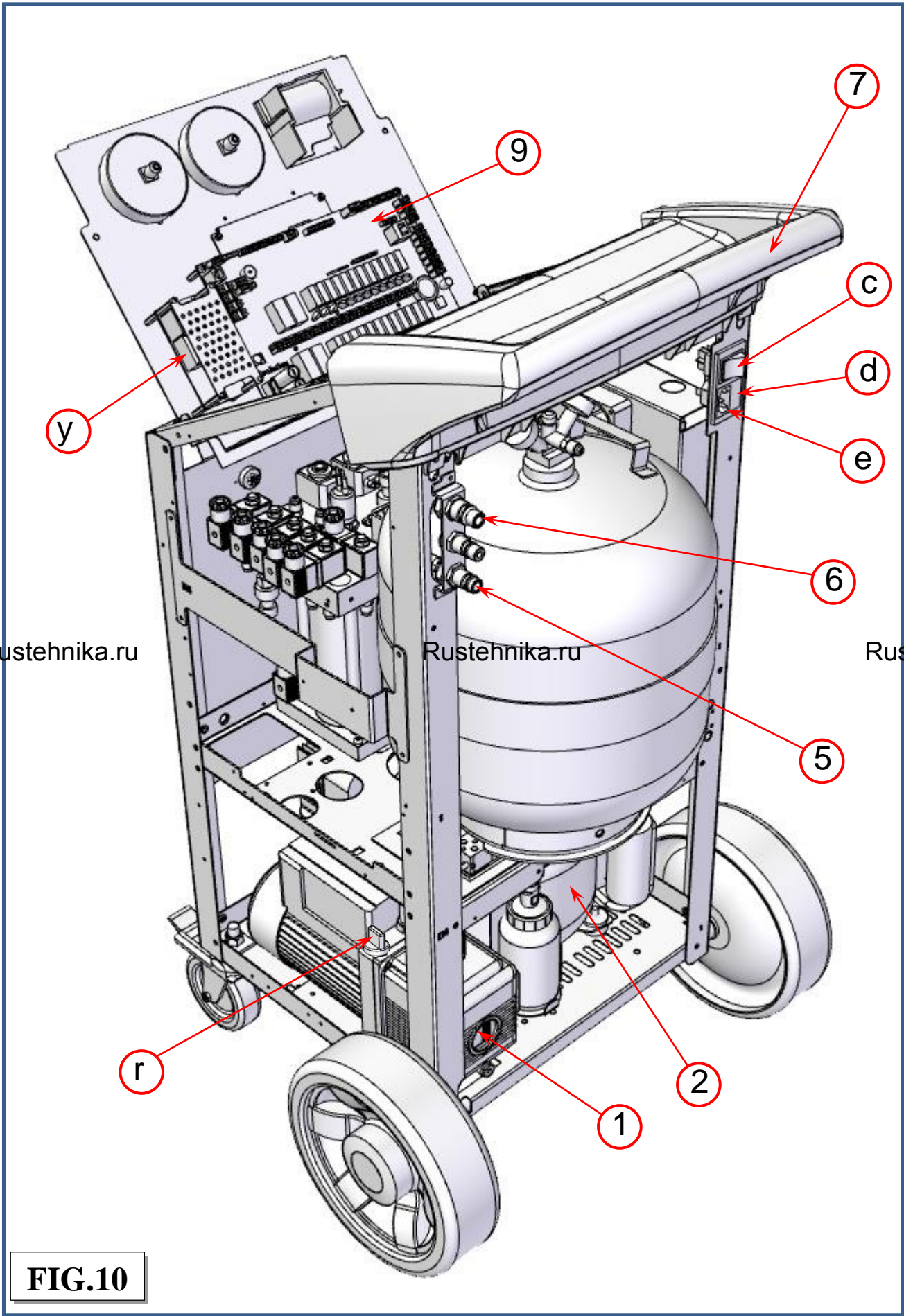

FIG.10

ALARMS

HIGH PRESSURE ALARM: Beeper advise when the pressure of the fluid in the circuit is too high (20bar). The recovery operation is automatically interrupted.

FULL BOTTLE ALARM: Beeper advise when the bottle is filled to more than 80% of maximum capacity (depending on machine model: 18kg for 22l bottle R134a or 10kg for 12l bottle R1234yf). The RECOVERY operation is automatically interrupted (to cancel this alarm, charge one or more A/C systems before recovering any more refrigerant).

EMPTY BOTTLE ALARM: Beeper advise when the quantity of refrigerant fluid contained in the bottle is low (less than 2kg)

VACUUM PUMP OIL CHANGE: Beeper advise after 20 hours of work of the vacuum pump; change the oil of the vacuum pump

SERVICE ALARM: Beeper advise whenever the total recovered refrigerant amounts to 100 kg. To deactivate the alarm, replace the filters and the vacuum pump oil. A code for canceling the alarm is supplied with the spare filters.

ERROR CODES

Error #1: The air or gas readings were unstable.

- Solution: Move the unit away from sources of EMF or RFI such as radio transmitters and arc welders.

Error #2: The air or gas readings were excessively high.

- Solution: Move the unit away from sources of EMF or RFI such as radio transmitters and arc welders.

Error #3: The air calibration resulted in a low output.

- Solution: Prevent refrigerant from flowing into the unit through the sample inlet during air calibration.
- Solution: Allow any refrigerant in the atmosphere to dissipate before performing air calibration

Error #4: The unit is beyond the operating temperature range

- Solution: Move the unit to an area where the ambient temperature is within the specified operating range.

Error #5: The refrigerant sampled has an excessively large amount of air or there was little or no sample flow due to plugged sample line gas analyzer filter. This is the code to prompt the user to change the filters. This should be considered more as a prompt than an actual error.

- Solution: Verify the coupler valve is open.
- Solution: Verify the gas analyzer filters are not plugged with debris or oil
- Solution: Replace gas analyzer filters

Error #6: SYSTEM LEAKS: Error message displayed when the A/C system is not tight

- Solution: Verify the connections between the service hoses and quick couplers, and make another 5 min vacuum test only on service hoses . If the problem persists, delete the residual oil in the service hoses making a short 100g filling in the service hoses and then a recovery, and repeat the 5 minutes vacuum test on service hoses.

N.B. if the vacuum test on service hoses passes, means that the A / C system has a loss which must be localized using a leak detector.

Error #7: : PRESENCE OF REFRIGERANT INTO THE A/C SYSTEM : Error message displayed when starting the vacuum, the charging station checks the presence of a pressure inside the A/C system:

- Solution: perform a recovery procedure

Error #8: LOW VACUUM error message displayed before filling if the value of the vacuum > 400mbar.

- Solution: Perform a quick vacuum procedure (at least 20 minutes)

Error #9: EMPTY TRACER CONTAINER: Error message displayed when the charging station is unable to complete the set amount of tracer injection.

- Solution: Fill the container with the correct amount of tracer for compressors, or replace the cartridge if it is refillable.

NOTE: using tracer not recommended by the manufacturer will void the warranty.

Error #10: EMPTY OIL CONTAINER: Error message displayed when the charging station is unable to complete the set amount of injection oil.

- Solution: Fill the container with the correct amount of new oil for compressors, or replace the cartridge if it is refillable.

NOTE: Use only oils recommended by the manufacturer or vehicle manufacturer. Never use oil used

Error #11: LOW GAS AVAILABILITY error message displayed during filling, when you select a quantity greater than the availability of gas.

- Solution: Fill the inner refrigerant bottle, refer to the homonymous section of the user manual

Error #12: VACUUM LEAKS (A/C system flushing): error message displayed during the A/C system flushing, leaks occurred during the test in a vacuum; A / C system is not tight

- Solution: Check the connections and repeat the procedure.

Error #13: PRESSURE LEAKS (A/C system flushing): error message displayed A/C system flushing, leaks occurred during the pressure test; A / C system is not tight

- Solution: Check the connections and repeat the procedure. If the problem persists, look for the leak using the appropriate tools (tracer or electronic leak detector)

Error #14: SYSTEM EMPTY: error message appears when you select a recovery procedure, but is not found pressure in the A/C system

- Solution: Check the connection and closing of the quick couplers, if after all these checks, the machine continues to give the same error means that the A/C system is empty

Error #18: SET QUANTITY LOWER THEN 100G: error message displayed during filling when the amount of gas typed is less than 100g (both automatic and manual procedure)

- Solution: set a quantity of gas greater than or equal to 100 grams

Error #21: N2 TEST NOT COMPLETED: This error message is displayed when, when a previously NITROGEN TEST has not been completed (eg due to switching off the charging station)

- Solution: Follow the onscreen instructions to purge the nitrogen present in the charging station

Error #22: N2 PRESSURE INSUFFICIENT: error message appears during N2 TEST because the inlet nitrogen pressure is very low and is not sufficient for the proper performance of the test.

- **Solution:** Check the connections between the external nitrogen bottle and the charging station, verify that the external nitrogen bottle is open, and that the pressure regulator is positioned between 8 and 12 bar

Error #23: N2 TEST LEAKS: error message displayed when the charging station encountered leaks during the NITROGEN TEST. A /C system is not in tight

- **Solution:** Check the connections and repeat the procedure. If the problem persists, look for the leak using the N2+H2 mixture and the special leak detector

Error #26: COMUNICATION ERROR: Error message displayed when the charging station loses its connection with the sanitiser or external analyzer

- **Solution:** verify the electrical connections of the sanitiser or the analyzer with the charging station. Power cycle the charging station

Error #27: LOW OIL VOLUME: error message displayed when the amount of oil / tracer set is greater than the amount available

- **Solution:** Fill the oil/tracer container

NOTE: using tracer not recommended by the manufacturer will void the warranty.

NOTE: Use only oils recommended by the manufacturer or vehicle manufacturer. Never use oil used

Error #30: CHECK CONNECTIONS: error message displayed when the flow rate of filling is too low

- **Solution:** Verify the correct opening of the quick couplers, make sure that the amount of gas in the refrigerant bottle is > 3 kg, otherwise fill the inner refrigerant bottle.

- Rarely, it may happen that the temperature of the engine compartment of the vehicle is too high compared to that of the charging station, this can cause an immediate balance between the refrigerant bottle pressure and A/C pressure causing a slowdown or interruption of the filling. To avoid this it is recommended not to do fill A/C in a vehicle exposed to the sun or a vehicle with the engine running.

Error #32: EMPTY EXTERNAL BOTTLE: error message appears during the process of filling the refrigerant bottle when the pressure drops to zero before the completion of the procedure

- **Solution:** Check the connections, quick couplers and valves on the external bottle; if the external bottle is empty, replace it with a full one, then run another filling.

Error # 33: HIGH PRESSURE ALARM: error message appears during the recovery procedure, internal bottle filling, emptying hoses, flushing hoses or A/C system flushing, this occurs when the hydraulic pressure reaches approximately 20 bar. The causes may be:

- Ambient temperature where is located in the station is too high. Solution to wait for a sufficient time to cool the charging station before resuming the interrupted procedure.
- Number of services performed by the station is excessive. Solution to wait for a sufficient time to cool the charging station before resuming the interrupted procedure.

One of the taps of the internal bottle is closed. Solution to open the tap and resume the interrupted procedure.

PRELIMINARY OPERATIONS

- Check that the main switch (ref.1, Fig.11) is set to O. Connect the machine to the electrical supply and switch on.

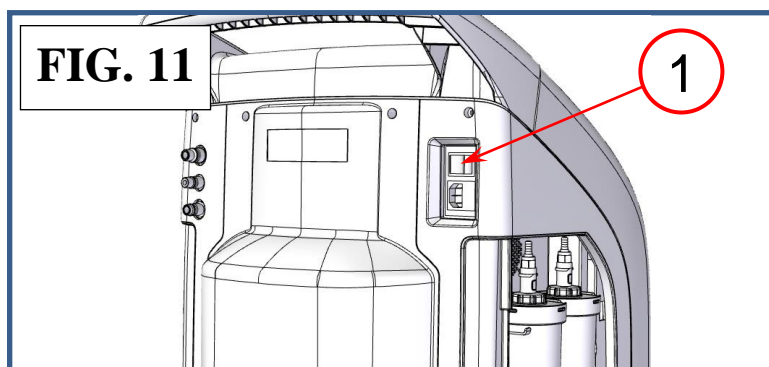

- At the startup the display show the name of the machine, sw version, ad date of release:

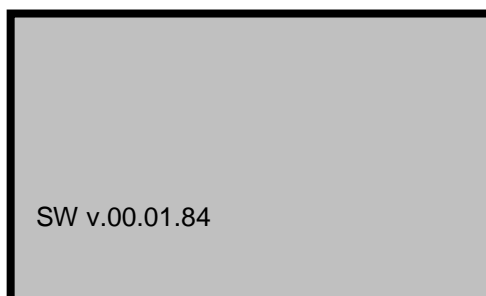

Rustehnika.ru

- Then the DATA MENU is visualized for 10 seconds (to exit earlier from this menu press BACK):

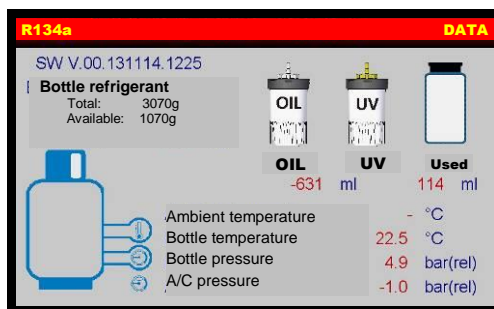

- The user can verify the all data of the machine :
 - o Check that the OIL, and UV containers aren't empty, if necessary operate the substitution as described in ORDINARY MAINTENANCE section.
 - o Check that the oil level in the used oil container is < 200 cc, if necessary empty it as described in ORDINARY MAINTENANCE section.
 - o Check on the machine display that there are at roughly 2 kg of refrigerant in the bottle. Should this not be the case, fill the on-board machine bottle from an external bottle of appropriate refrigerant following the procedure described in the BOTTLE FILLING (ORDINARY MAINTENANCE)

- Check that the vacuum pump oil level indicator (ref.3, Fig.12) shows at least one-half full. If the level is lower, add oil as explained in the MAINTENANCE section.

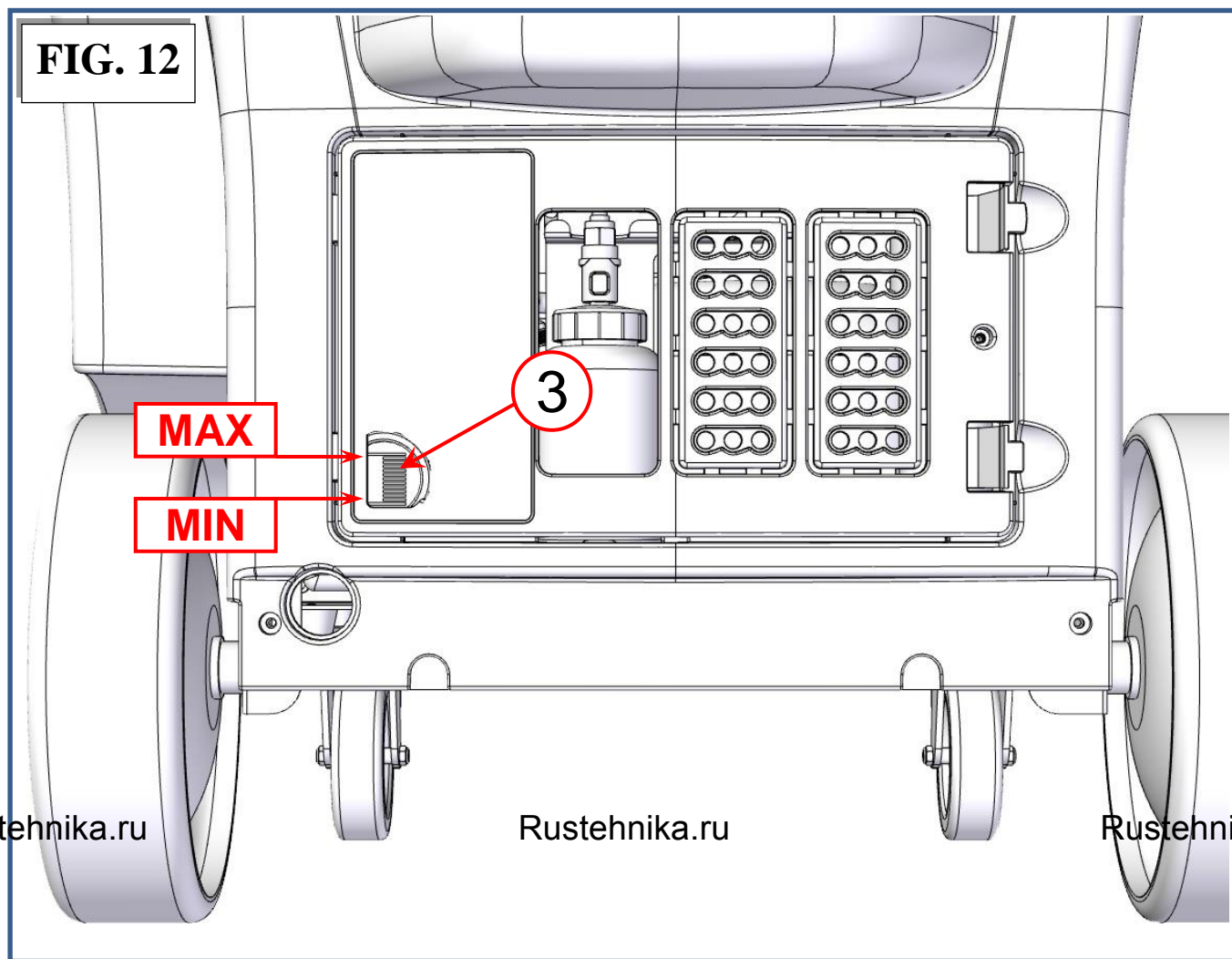

AUTOMATIC PROCEDURE

In the automatic mode, all the operations are performed automatically: recovery and recycling, oil discharge, vacuum, new oil reintegration, and charging. The values for the quantity of gas recovered, quantity of oil recovered, vacuum time, quantity of oil reintegrated, and quantity of gas charged into the system are automatically printed at the end of each single operation.

Connect the hoses to the A/C system with the quick-connect couplings bearing in mind that BLUE must be connected to the low-pressure side and RED to high pressure. If the A/C system is equipped with a single quick-connect coupling for high or low pressure, connect only the relative hose.

From the MAIN MENU:



Select the AUTOMATIC PROCEDURE, the following screen is displayed (only if the hardware for hybrid vehicles is installed in the machine):

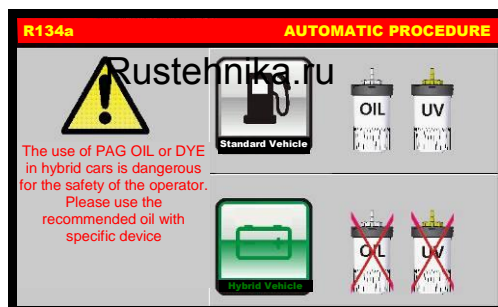

Select the STANDARD VEHICLE or HYBRID VEHICLE; the following screen will be displayed:

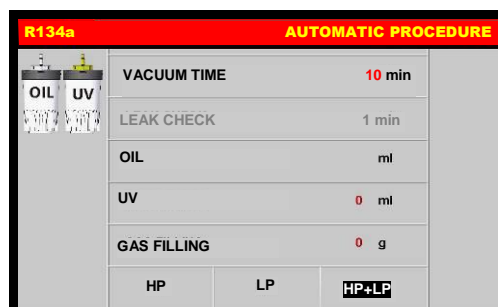

NOTE: When HYBRID VEHICLE is selected UV is disabled (except HYBRID UV).

NOTE: use arrows to scroll through menu items, then use the keypad to modify procedure parameters

Edit VACUUM data:

use the KEYPAD to insert the new value of the VACUUM TIME, press OK to confirm, BACK to return back.

NOTE: use the VACUUM SETTING to change the duration of the LEACK CHECK.

NOTE: if selected VACUUM TIME is lower 15 minutes the following popup warning will be displayed:

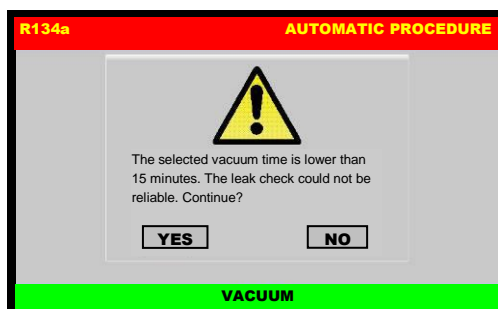

Press YES to continue, or press NO to go back.

Edit OIL data:

Use arrow to select OIL, then use the keys 0 to 9 to type the volume of oil to be injected, or select AUTO to reintegrate the same quantity of oil extracted during Recovery.

Rustehnika.ru

Rustehnika.ru

Rustehnika.ru

Edit UV data:

Use arrow to select UV *, then use the keys 0 to 9 to type the volume of UV to be injected (type "0" for no UV injection)

* UV is disabled while servicing HYBRID VEHICLE

Edit GAS FILLING data:

NOTE: For most systems the quantity of fluid to be refilled is indicated on a plate that is in the vehicle's engine compartment. If this quantity is not known, look for it in the relevant manuals.

Use arrow to select GAS FILLING, then use the keys 0 to 9 to type the quantity (in grams) of refrigerant to be charged into the A/C system.

NOTE: If DATABASE is installed, can be used to insert the value of refrigerant into the GAS FILLING field.

NOTE: if gas filling is lower than 100 grams the following popup warning will be displayed:

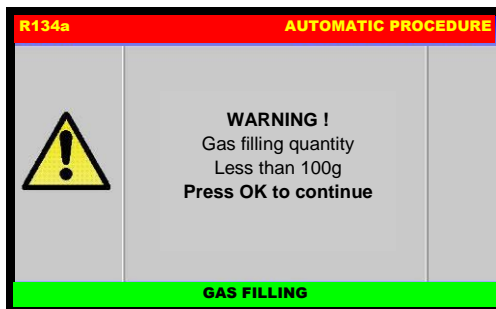

Gas filling lower than 100 grams is not allowed, press OK then digit an higher amount of gas filling.

Edit GAS FILLING mode:

Select the connection mode:

- HP+LP fill the refrigerant from both HP and LP service ports
- HP to fill the refrigerant only from the HP service port,
- LP to fill the refrigerant only from the LP service port,

START AUTOMATIC PROCEDURE:

After selected all the procedure data, press OK to continue. If sanitizer is enabled, the following screen will be displayed:

Rustehnika.ru



Rustehnika.ru

Select YES to perform a PURIFICATION during the AUTOMATIC PROCEDURE (refer to Sanitizer instruction manual [MANU040.IGN]), or press NO to skip it, then the following screen will be displayed:



Type the plate of the car, press OK to confirm. BACK to return back.

NOTE: the numerical keys include an alphabet that is used similar to text messaging; for example: press "2" once to display "A", twice to display "B", three time for "C", four time for "2".

If gas analyzer is installed, The machine will test the purity of the refrigerant gas in the A/C system before beginning recovery (refer to Gas analyzer instruction manual [MANU043.ANL]).

Then SUMMARY SCREEN will be displayed:

R134a		AUTOMATIC PROCEDURE	
VACUUM TIME		1	min
OIL INJECTION		0	ml
UV		0	ml
GAS FILLING		333	g
CONNECTION MODE		HP + LP	
VEHICLE PLATE		63652	
Press OK to start the procedure			

Press OK to confirm the displayed values and start the procedure, BACK to return back.

The following screen will be displayed:

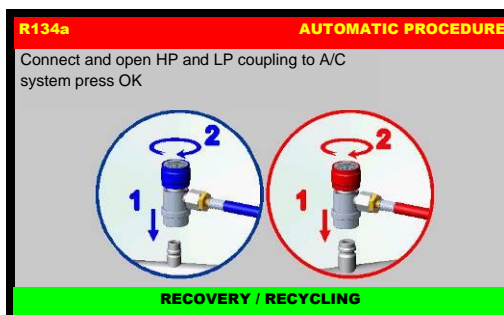

Connect and open the coupling to the A/C system, then press OK, press BACK to return back.

the AUTOMATIC PROCEDURE will start, and the following screen will be displayed:

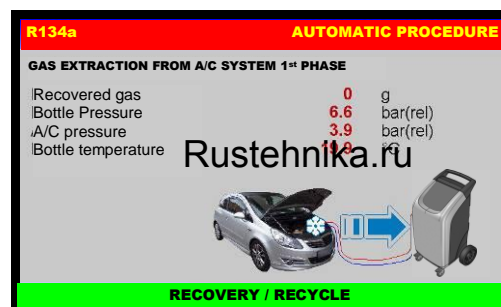

During the recovery phase, the machine displays the quantity of refrigerant recovered, in grams. Upon completion of recovery, the machine will stop and discharge, while automatically displaying the used oil extracted from the A/C system during the recovery phase.

The oil discharge operation lasts 4 minutes.

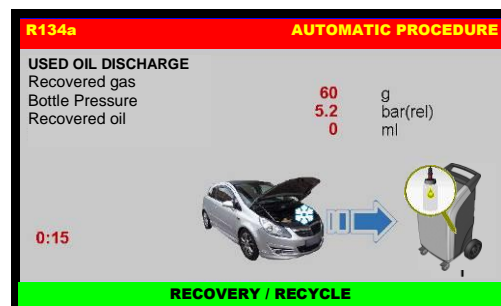

The machine checks whether or not there is air in the bottle and, if necessary, purges the non-condensable gas; The machine will automatically discharge any non-condensable gas.

Allowing the machine to fully complete the procedure will reduce the risk of return flows, which may cause excessive non-condensable gas to be recharged into the air conditioning system. If any residual refrigerant in the A/C system should increase in pressure during this phase, the machine will automatically begin recovering the refrigerant.

Completed the recovery phase, the machine automatically goes on to running the vacuum phase for the preset time:

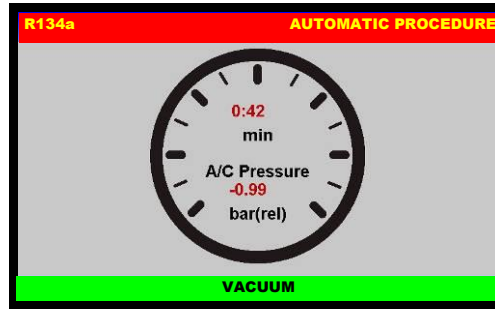

At the end of this phase, the machine will test for leaks in the A/C system :

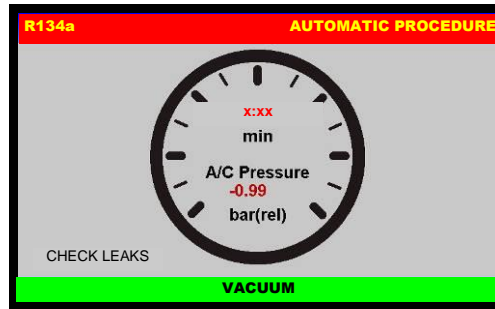

(WARNING! If vacuum time < 15 minutes this test is not reliable). If leaks are found, the machine will stop automatically and display the A/C SYSTEM LEAKS alarm.

Detection of micro-leaks is not guaranteed.

Upon completion of the vacuum phase, new oil will be automatically reintegrated: the volume will be equal to that of the used oil discharged or to the volume set by the operator.



the quantity of UV set by the operator will be automatically reintegrated.

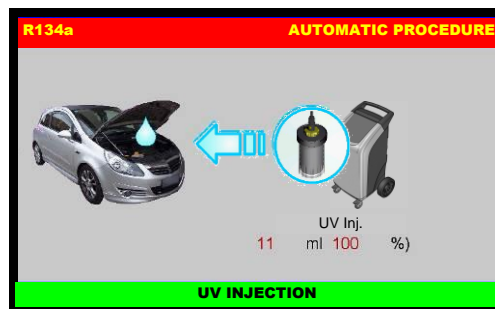

When completed, the system will go on to charging with the preset quantity of refrigerant.

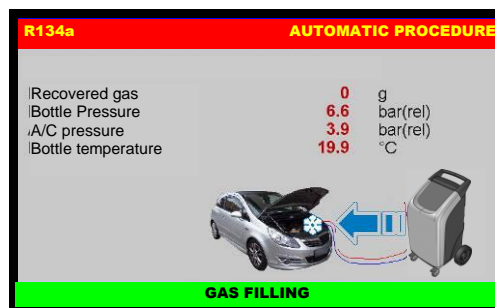

Then the following screen will be displayed:

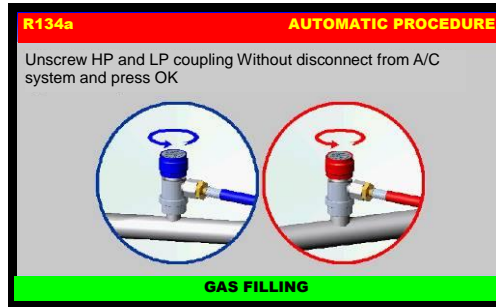

Unscrew HP and LP coupling without disconnect from A/C system end press OK to continue:

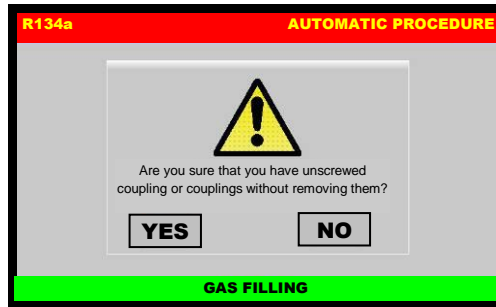

A pop-up message is displayed asking confirmation, press YES to continue:

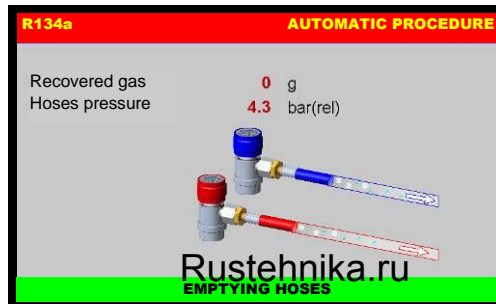

Rustehnika.ru

Rustehnika.ru

The machine will recover the residual refrigerant into the service hoses, then the following screen will be displayed:

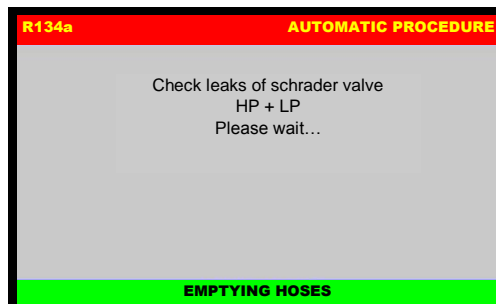

The machine will check if the Schrader valve of the coupling are tightened (only if puff-free coupling are installed, and puff-free option is enabled on the machine), then the following screen will be displayed:

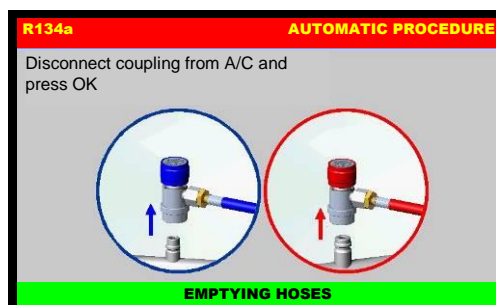

Disconnect coupling from A/C system.

Automatic procedure is now successfully completed.

NOTE: Rarely, charging may not run to completion due to pressure balance. In this case, close the high pressure tap (leaving the low-pressure side open), and switch on the A/C system.

NOTE: The automatic procedure may be run even if the A/C system is empty. In this case the machine will begin with the vacuum phase.

MANUAL PROCEDURE

In the MANUAL PROCEDURE, all the operations can be performed singly to the exception of the recovery/recycling phase, which is automatically followed by used oil discharge.

The values for the quantity of gas recovered, quantity of oil recovered, vacuum time, quantity of oil reintegrated, and quantity of gas charged into the system are automatically printed at the end of each single operation.

From the MAIN MENU:



Select the MANUAL PROCEDURE, the following screen will be displayed:

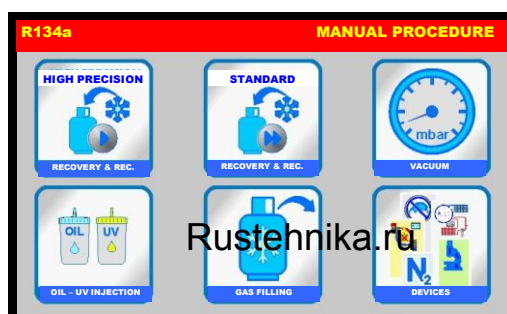

Rustehnika.ru

Rustehnika.ru

Rustehnika.ru

HIGH PRECISION RECOVERY

Connect the hoses to the A/C system with the quick-connect couplings, bearing in mind that BLUE must be connected to the low-pressure side and RED to high pressure.

If the A/C system is equipped with a single quick-connect coupling for high or low pressure, connect only the relative hose.

From MANUAL PROCEDURE, select HIGH PRECISION RECOVERY, the following screen will be displayed:

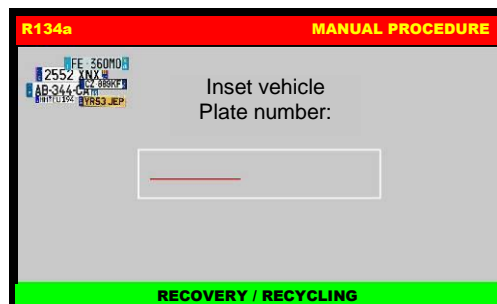

Type the plate of the car, press OK to confirm. BACK to return back.

NOTE: the numerical keys include an alphabet that is used similar to text messaging; for example: press “2” once to display “A”, twice to display “B”, three time for “C”, four time for “2”.

the following screen will be displayed:

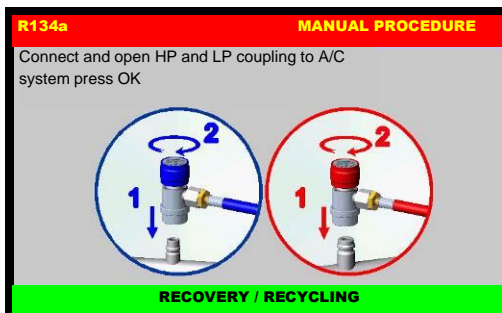

Connect and open the coupling to the A/C system, then press OK, press BACK to return back. the following screen will be displayed:

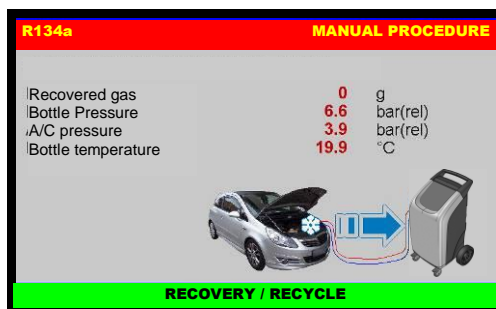

During the recovery phase, the machine displays the quantity of refrigerant recovered, in grams.

Upon completion of recovery, the machine will stop and discharge, while automatically displaying the used oil extracted from the A/C system during the recovery phase. The oil discharge operation lasts 4 minutes.

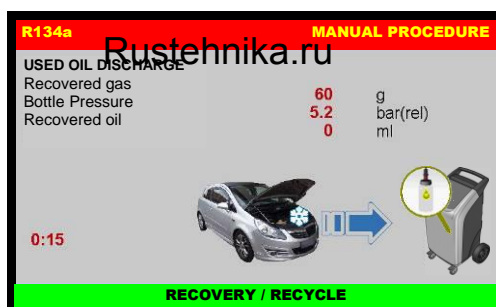

The machine checks whether or not there is air in the bottle and, if necessary, purges the non-condensable gas; The machine will automatically discharge any non-condensable gas.

Allowing the machine to fully complete the procedure will reduce the risk of return flows, which may cause excessive non-condensable gas to be recharged into the air conditioning system. If any residual refrigerant in the A/C system should increase in pressure during this phase, the machine will automatically begin recovering the refrigerant.

Then the machine sounds an alarm while the following screen is displayed:

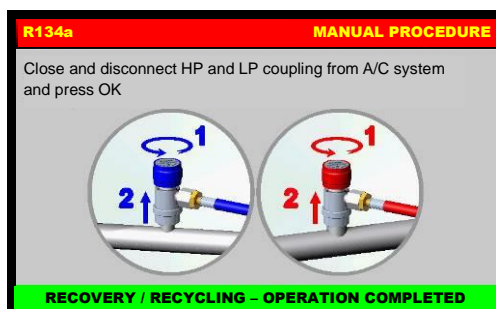

Unscrew and disconnect HP and LP coupling from A/C system end press OK to complete the RECOVERY / RECYCLE PROCEDURE.

STANDARD RECOVERY

From MANUAL PROCEDURE, select STANDARD RECOVERY, the machine will run a recovery phase as described by the previous HIGH PRECISION RECOVERY chapter, but **without SAE J-2788 or SAE J-2843 compliance.**

VACUUM

Use the quick-connect couplings to connect the hoses to the A/C system, bearing in mind that BLUE must be connected to the low pressure side and RED to high pressure. If the system is equipped with a single quick-connect coupling for high or low pressure, connect only the relative hose.

From the MANUAL PROCEDURE, select VACUUM, the following screen will be displayed:

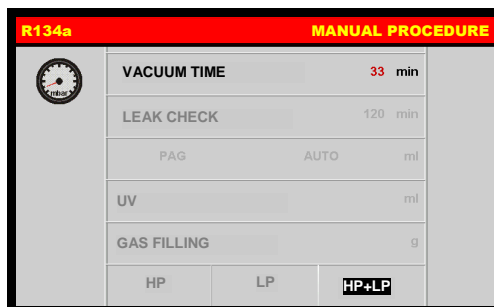

use the KEYPAD to insert the new value of the VACUUM TIME, press OK to confirm, BACK to return back.

NOTE: LEAK CHECK could be not displayed (depending of machine model).

NOTE: use the VACUUM SETTING to change the duration of the LEACK CHECK.

NOTE: if selected VACUUM TIME is lower 15 minutes the following popup warning will be displayed:

Rustehnika.ru

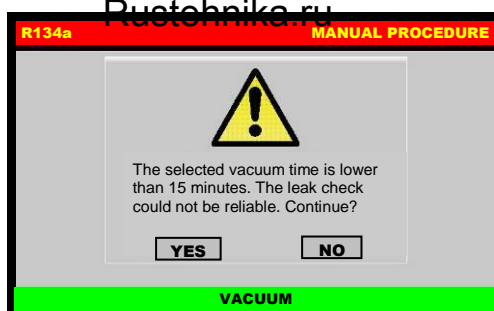

Rustehnika.ru

Press YES to continue, or press NO to go back.

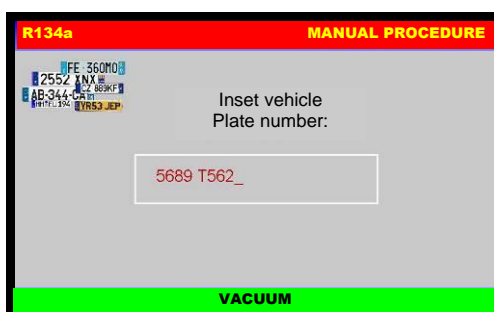

Type the plate of the car, press OK to confirm. BACK to return back.

NOTE: the numerical keys include an alphabet that is used similar to text messaging; for example: press “2” once to display “A”, twice to display “B”, three time for “C”, four time for “2”.

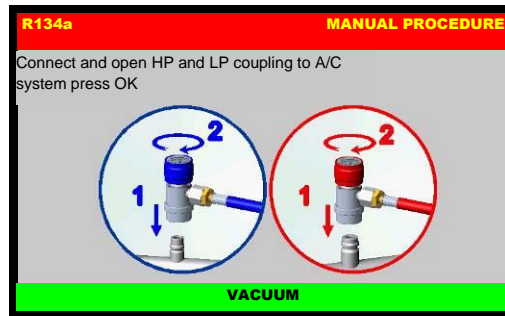

Connect and open the coupling connected to the A/C system, then press OK to start the vacuum phase, press BACK to return back.

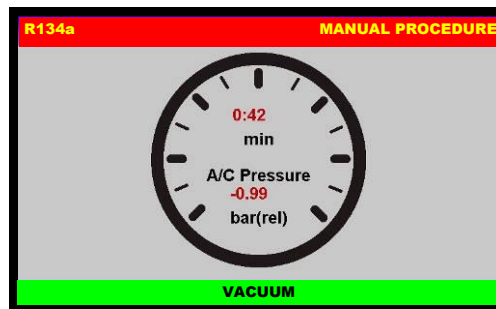

When time of check is reached, the machine will test for leaks in the A/C system:

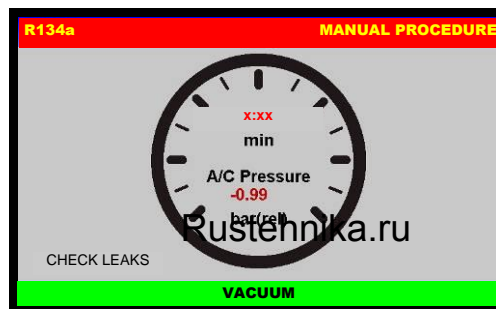

Rustehnika.ru

Rustehnika.ru

(WARNING! If vacuum time is lower than 15 minutes this test is not reliable). If leaks are found, the machine will stop automatically and display the A/C SYSTEM LEAKS alarm.

Detection of micro-leaks is not guaranteed.

At the end of the preset vacuum time, the machine will sound and alarm and the following screen will be displayed:

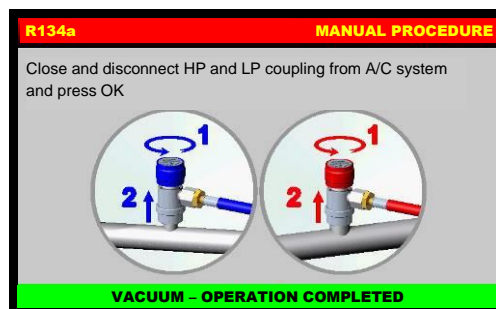

Close and disconnect HP and LP coupling from A/C system, then press OK to return to the MAIN MENU; VACUUM PROCEDURE is now successfully completed.

OIL+UV INJECTION

This operation can be carried out ONLY following a VACUUM operation.

From the MANUAL PROCEDURE, select OIL+UV INJECTION, the following screen is displayed (only if the hardware for hybrid vehicles is installed in the machine):

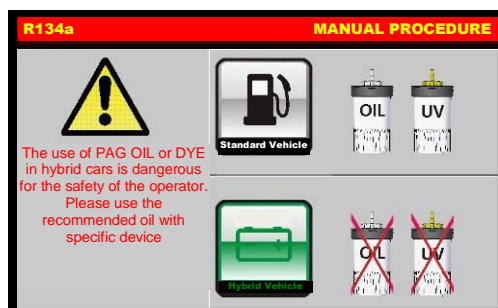

Select the STANDARD VEHICLE or HYBRID VEHICLE; the following screen will be displayed:

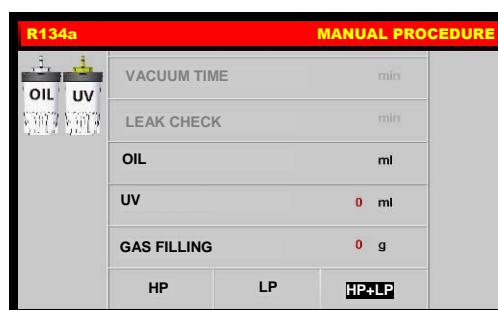

NOTE: When HYBRID VEHICLE is selected UV is disabled (except HYBRID UV).

NOTE: use arrows to scroll through menu items, then use the keypad to modify procedure parameters

Edit OIL data

Use arrow to select OIL, then use the keys 0 to 9 to type the volume of oil to be injected.

Edit UV data

Use arrow to select UV*, then use the keys 0 to 9 to type the volume of UV to be injected (type "0" for no UV injection), can never be more than 10 ml.

* UV is disabled while servicing HYBRID VEHICLE

Edit GAS FILLING data

NOTE: For most systems the quantity of fluid to be refilled is indicated on a plate that is in the vehicle's engine compartment. If this quantity is not known, look for it in the relevant manuals.

Use arrow to select GAS FILLING, then use the keys 0 to 9 to type the quantity (in grams) of refrigerant to be charged into the A/C system.

NOTE: If DATABASE is installed, can be used to insert the value of refrigerant into the GAS FILLING field.

NOTE: if gas filling is lower than 100 grams the following popup warning will be displayed:

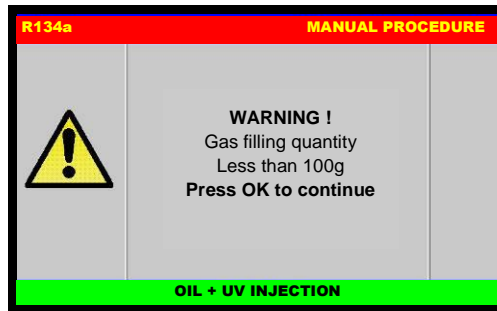

Gas filling lower than 100 grams is not allowed, press OK then digit an higher amount of gas filling.

Edit GAS FILLING mode

Select the connection mode:

- HP+LP fill the refrigerant from both HP and LP service ports
- HP to fill the refrigerant only from the HP service port,
- LP to fill the refrigerant only from the LP service port,

START procedure

After selected all the procedure data, press OK to continue, the following screen will be displayed:

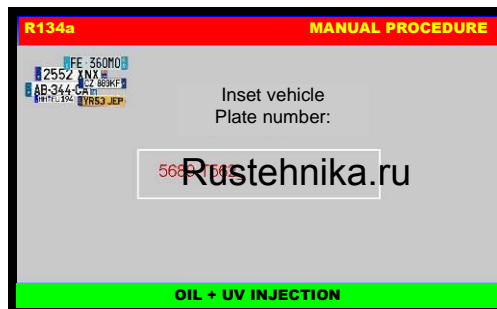

Rustehnika.ru

Rustehnika.ru

Type the plate of the car, press OK to confirm. BACK to return back.

NOTE: the numerical keys include an alphabet that is used similar to text messaging; for example: press "2" once to display "A", twice to display "B", three time for "C", four time for "2".

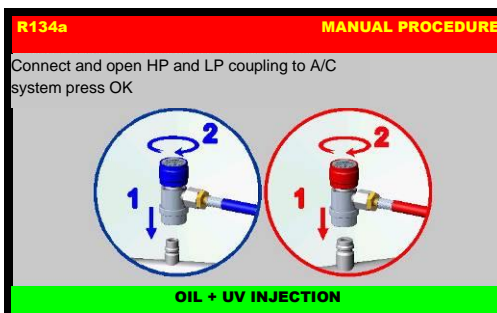

Connect and open the coupling (HP, LP, or HP/LP, depend of the previous choice) connected to the A/C system, then press OK, press BACK to return back.



Oil will be injected, then if previously selected the UV will be injected :

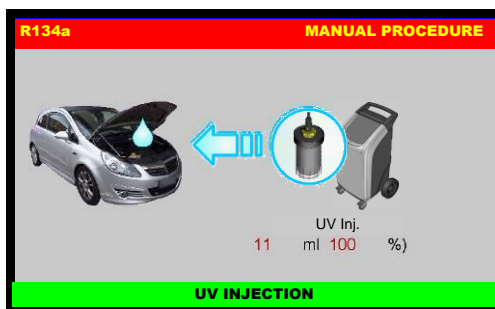

The machine will continue the refilling with the preset quantity of refrigerant.

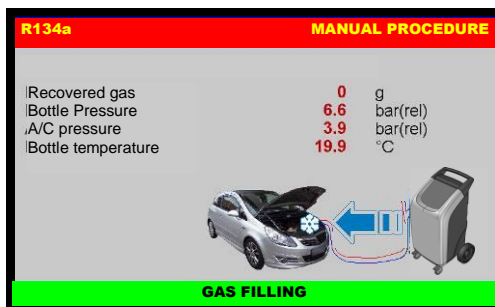

Then the following screen will be displayed:

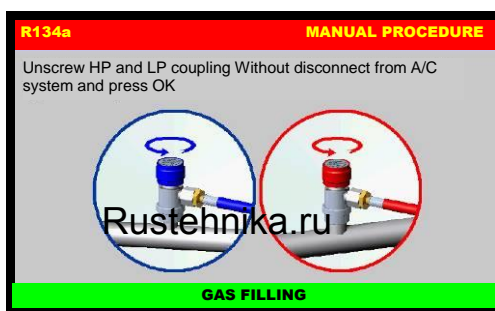

Unscrew HP and LP coupling without disconnect from A/C system end press OK to continue:

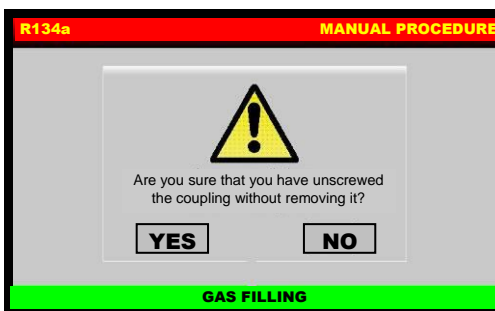

A pop-up message is displayed asking confirmation, press YES to continue:

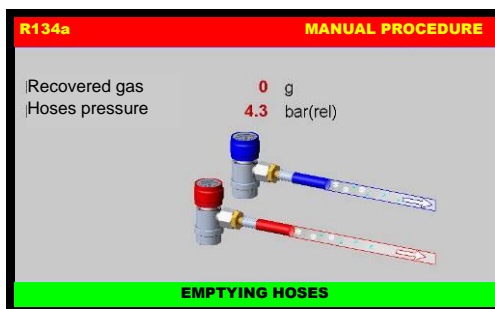

The machine will recover the residual refrigerant into the service hoses, then the following screen will be displayed:

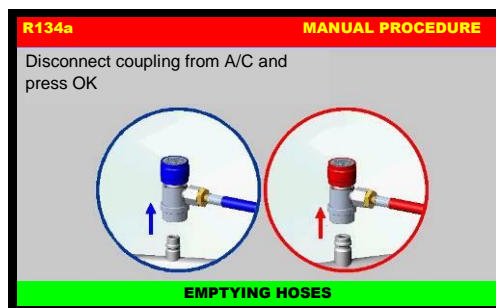

Disconnect coupling from A/C system.

Procedure is now successfully completed.

NOTE: Rarely, charging may not run to completion due to pressure balance. In this case, close the high pressure tap (leaving the low-pressure side open), and switch on the A/C system.

FILLING

From the MANUAL PROCEDURE, select FILLING, the following screen will be displayed:

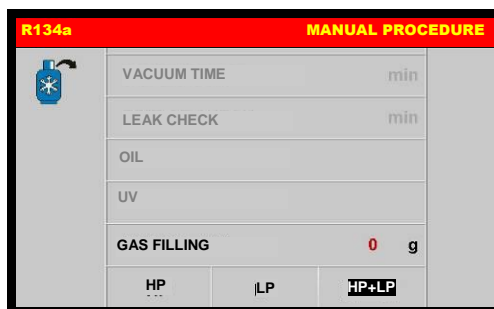

Edit GAS FILLING data

NOTE: For most systems the quantity of fluid to be refilled is indicated on a plate that is in the vehicle's engine compartment. If this quantity is not known, look for it in the relevant manuals.

Press GAS FILLING button to enable active box (turn yellow), then use the keys 0 to 9 to type the quantity (in grams) of refrigerant to be charged into the A/C system.

NOTE: If DATABASE is installed, can be used to insert the value of refrigerant into the GAS FILLING field.

NOTE: if gas filling is lower than 100 grams the following popup warning will be displayed:

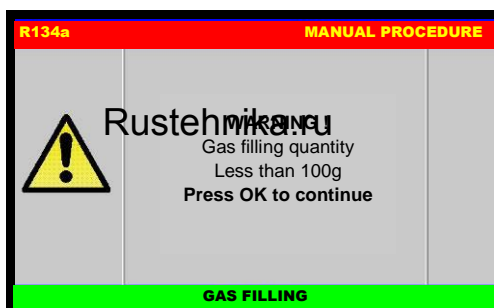

Gas filling lower than 100 grams is not allowed, press OK then digit an higher amount of gas filling.

Edit GAS FILLING mode

Select the connection mode:

- HP+LP fill the refrigerant from both HP and LP service ports
- HP to fill the refrigerant only from the HP service port,
- LP to fill the refrigerant only from the LP service port,

START procedure

After selected all the procedure data, press OK to continue, the following screen will be displayed:

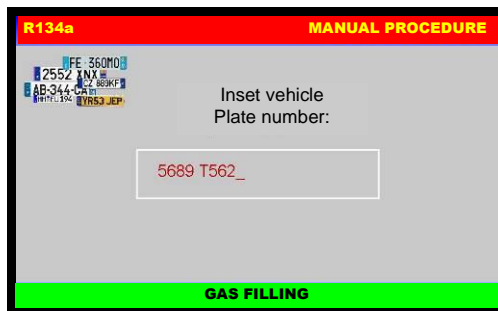

Type the plate of the car, press OK to confirm. BACK to return back.

NOTE: the numerical keys include an alphabet that is used similar to text messaging; for example: press “2” once to display “A”, twice to display “B”, three time for “C”, four time for “2”.

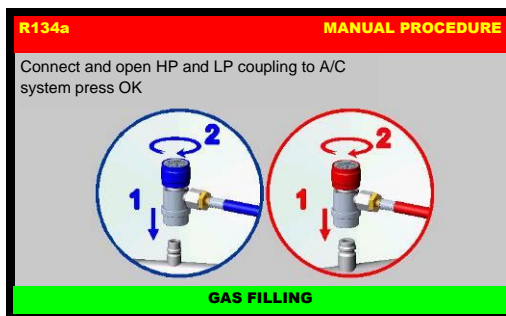

Connect and open the coupling (HP, LP, or HP/LP, depend of the previous choice) connected to the A/C system, then press OK, press BACK to return back.

The machine will start the filling with the preset quantity of refrigerant.

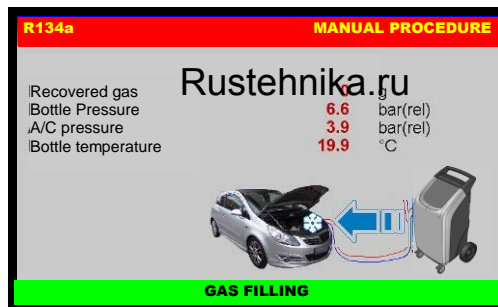

Rustehnika.ru

Rustehnika.ru

Then the following screen will be displayed:

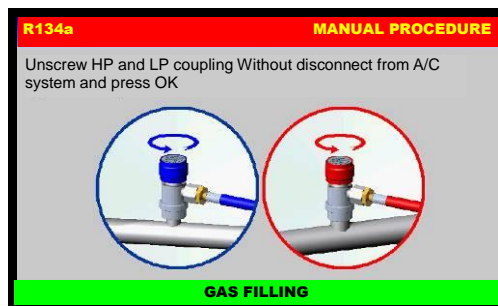

Unscrew HP and LP coupling without disconnect from A/C system end press OK to continue:

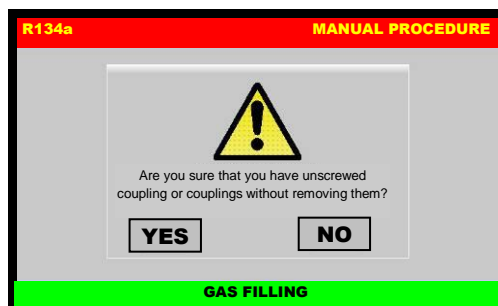

A pop-up message is displayed asking confirmation, press YES to continue:

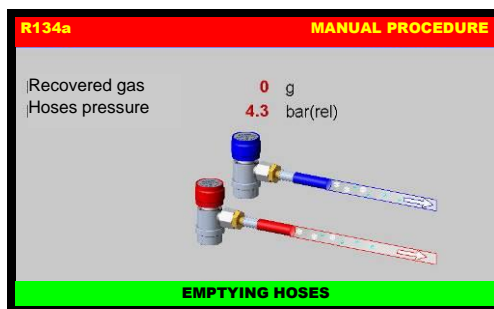

The machine will recover the residual refrigerant into the service hoses, then the following screen will be displayed:

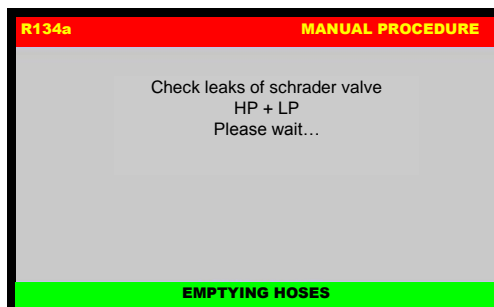

The machine will check if the Schrader valve of the coupling are tightened (only if puff-free coupling are installed, and puff-free option is enabled on the machine), then the following screen will be displayed:

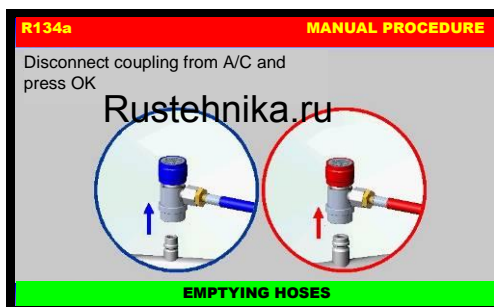

Disconnect coupling from A/C system.

Procedure is now successfully completed.

NOTE: Rarely, charging may not run to completion due to pressure balance. In this case, close the high pressure tap (leaving the low-pressure side open), and switch on the A/C system.

FLUSHING HOSES^(optional)

This operation makes the machine suitable for a service on vehicles equipped with electrically driven compressors (hybrid vehicles)

From the MANUAL PROCEDURE, select DEVICES:

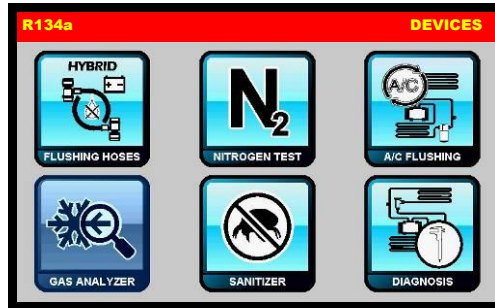

Then select FLUSHING HOSES, the following screen will be displayed:

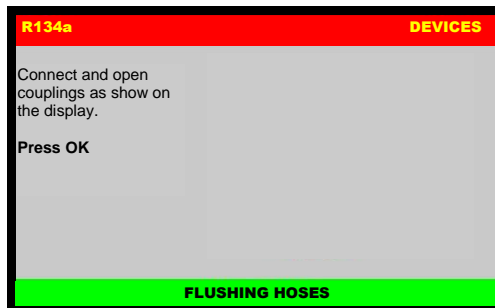

Connect the HP and LP couplers to the respective fitting on the machine, the press OK to continue.

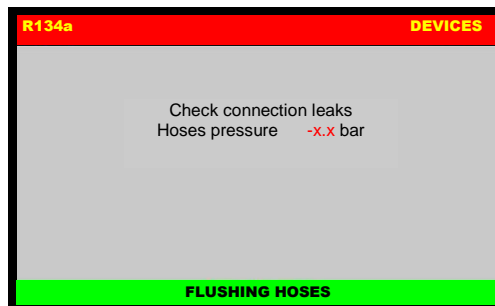

After checking connection leaks, the following screen will be displayed:

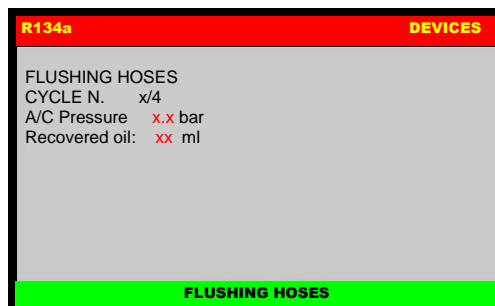

Flushing hoses lasts few minutes, then the machine will sound and alarm and the following screen will be displayed:

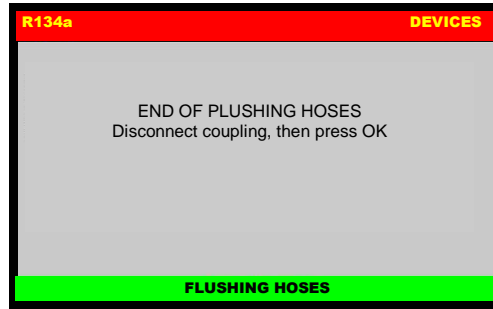

Disconnect coupling, then press OK to return to the MAIN MENU; FLUSHING HOSES is now successfully completed.

NITROGEN TEST (optional)

From the MANUAL PROCEDURE, select DEVICES:

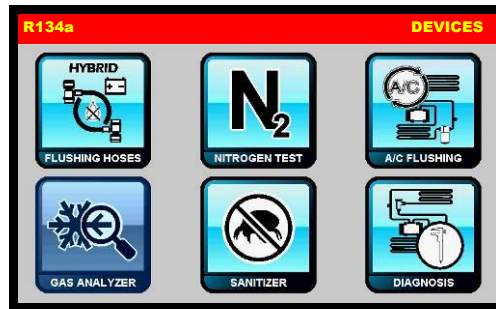

Then select NITROGEN TEST, the following screen will be displayed:

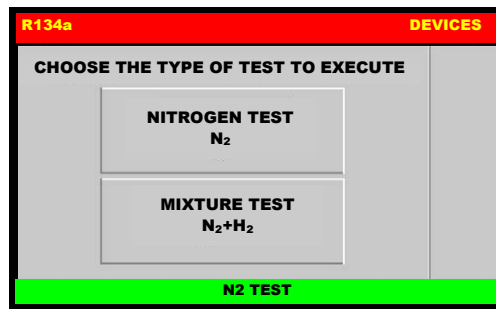

Select a test or press BACK to return to DEVICES menu.

NITROGEN TEST (N₂)

This operation allows to test the seal of the A/C system using pressurized nitrogen

Selecting NITROGEN TEST the following screen will be displayed:

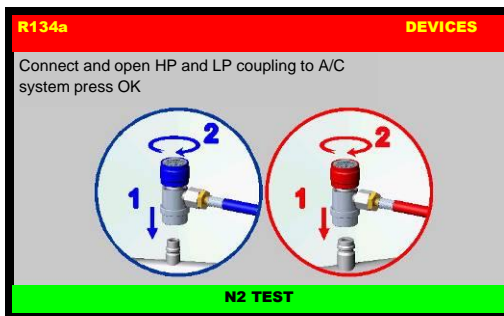

Connect and open HP and LP coupling to A/C system, then press OK to continue; the following screen will be displayed:

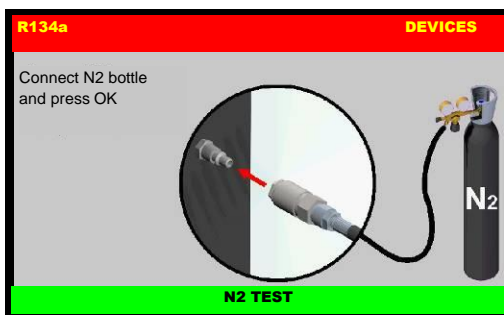

Connect nitrogen bottle and press OK:



Regulate pressure reducer between 8 and 12 bar and press OK:

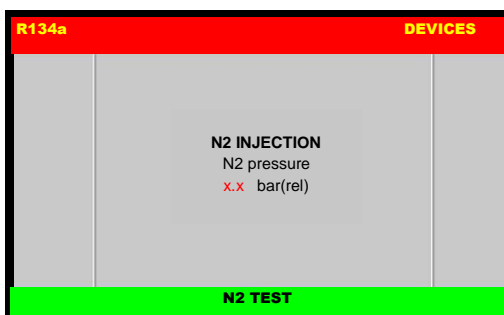

The nitrogen will be injected into the A/C system, the test will start as soon as the pressure is stable:

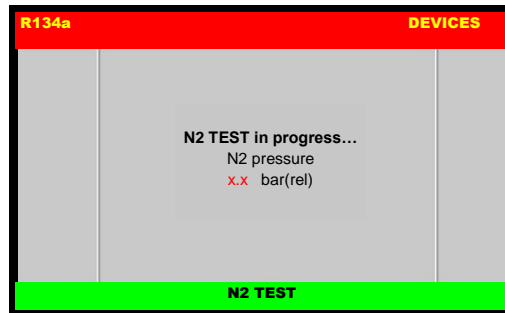

If leaks are detected, the machine will give an alarm signal, discharge the nitrogen from the system, and display a SYSTEM LEAKS alarm warning. If the test detects no leaks, the machine will discharge the nitrogen:

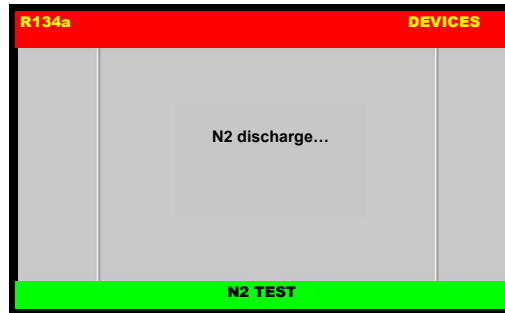

then the machine will sound and alarm and the following screen will be displayed:

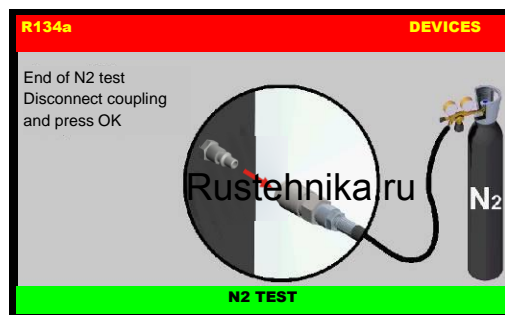

Rustehnika.ru

Rustehnika.ru

Disconnect coupling, then press OK the following screen will be displayed:

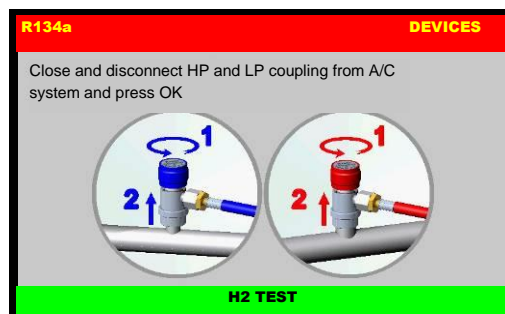

Unscrew and disconnect HP and LP coupling from A/C system end press OK to complete the N2 TEST.

WARNING: Connect nitrogen supply only to the quick-connect coupling

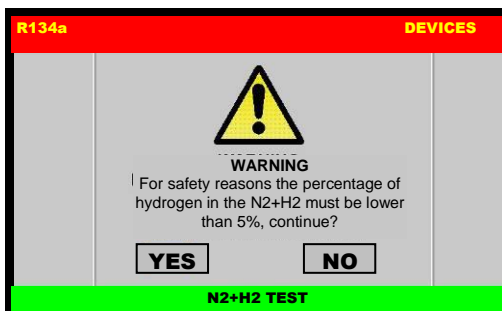
MIXTURE TEST (N₂+H₂)**WARNING: For safety reasons the percentage of hydrogen in the N₂+H₂ must be lower than 5%**Selecting MIXTURE TEST (N₂+H₂) the following screen will be displayed:

Press NO to return back, or press OK to continue:

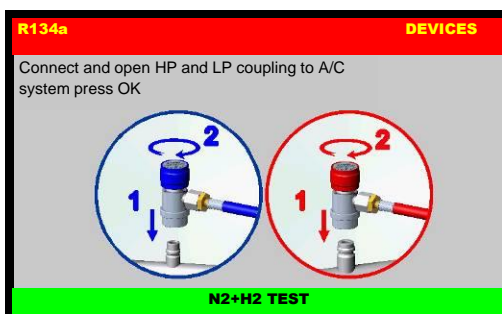

Connect and open HP and LP coupling to A/C system, then press OK to continue; the following screen will be displayed:

Rustehnika.ru

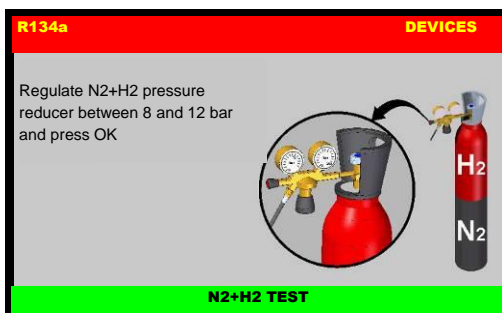

Rustehnika.ru

Connect mixture (N₂+H₂) bottle and press OK:

Regulate pressure reducer between 8 and 12 bar and press OK:

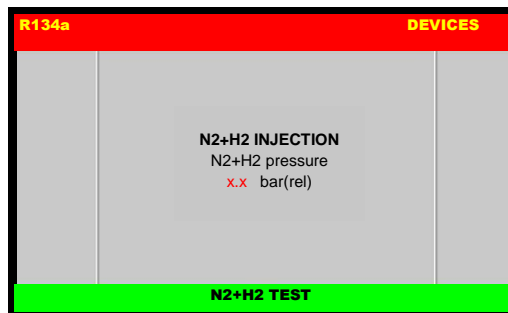

The mixture (N_2+H_2) will be injected into the A/C system, the test will start as soon as the pressure is stable:

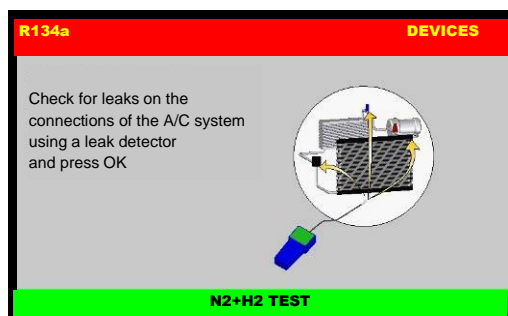

Check for leaks on the connections of the A/C system using a leak detector, then press OK to continue. The machine will discharge the mixture:

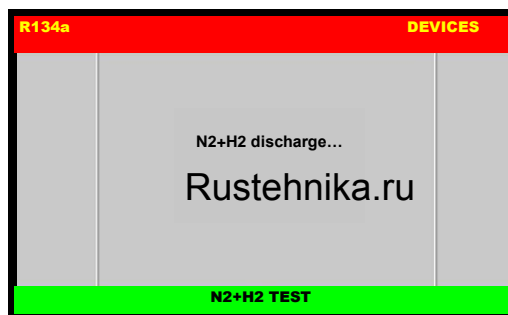

Rustehnika.ru

Rustehnika.ru

then the machine will sound and alarm and the following screen will be displayed:

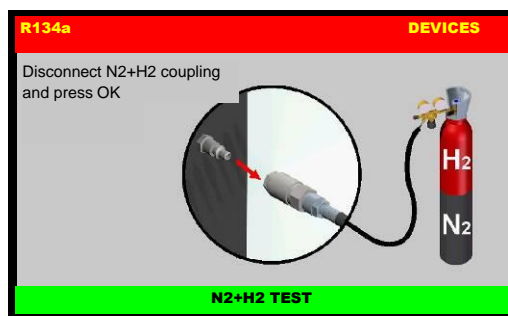

Disconnect coupling, then press OK the following screen will be displayed:

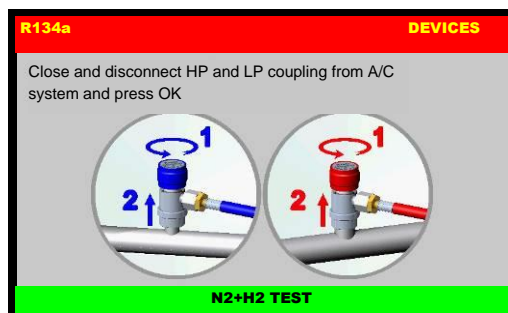

Unscrew and disconnect HP and LP coupling from A/C system end press OK to complete the MIXTURE TEST (N₂+H₂).

WARNING: Connect mixture supply only to the quick-connect coupling

A/C SYSTEM FLUSHING^(optional)

Attention: before flushing, recover the refrigerant of the a/c system using a suitable R&R device, then run at least 20 minutes vacuum.

When flushing a system we recommend disassembling the filter and the expansion valve, in the case of a traditional system, or only the capillary valve in the case of a flooded system. Use the inlet to the evaporator as washing inlet and the outlet of the condenser as flushing outlet.

From DEVICES, select A/C SYSTEM FLUSHING, the following screen will be displayed:

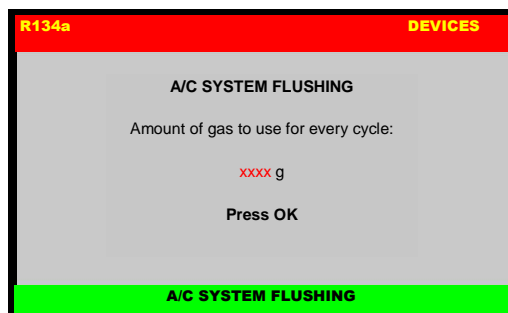

If needed, type the new value; then press OK to continue, the following screen will be displayed:

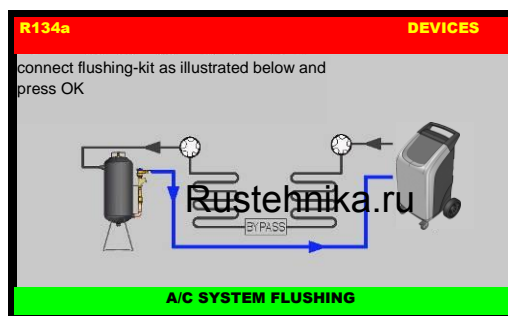

Connect the flushing kit as described previously, then press OK to begin the flushing operation:

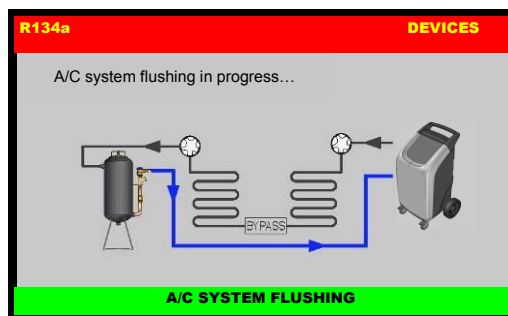

The machine will proceed automatically, displaying the quantity of oil extracted and printing the total volume at the end of flushing. When flushing is completed, the following screen is displayed:

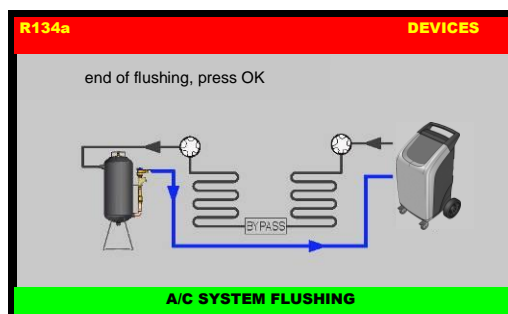

Press OK, disconnect all the couplings and disconnect the machine from the power supply.

NOTE: for additional information about PRINCIPAL COMPONENTS, ASSEMBLY OF THE FLUSHING KIT, CONNECTION TO THE SYSTEM and FLUSHING KIT MAINTENANCE, please refer to A/C SYSTEM FLUSHING INSTRUCTIONS [MANU029.NFK].

Rustehnika.ru

Rustehnika.ru

Rustehnika.ru

GAS ANALYZER^(optional)

From the MANUAL PROCEDURE, select DEVICES:

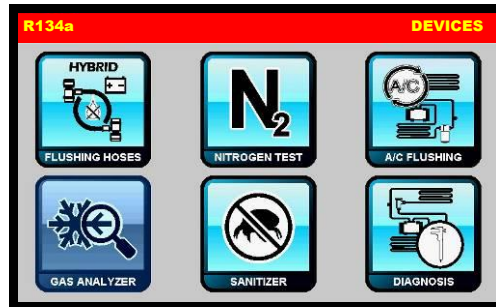

Then select GAS ANALYZER; if gas analyzer is installed, The machine will test the purity of the refrigerant gas in the A/C system (refer to [Gas analyzer instruction manual \[MANU043.ANL\]](#)).

SANITIZER^(optional)

From the MANUAL PROCEDURE, select DEVICES:

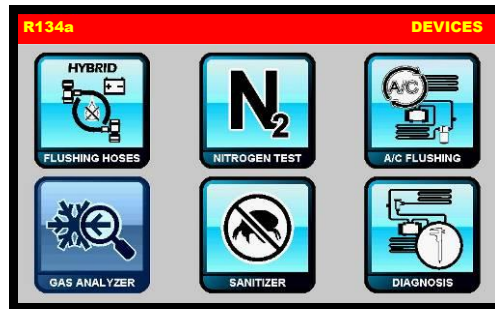

Then select SANITIZER to perform a PURIFICATION (refer to [Sanitizer instruction manual \[MANU040.IGN\]](#)).

DYNAMIC DIAGNOSIS^(optional)

DYNAMIC DIAGNOSTICS is an additional machine function that permits diagnosing the causes of malfunctions in vehicle A/C systems by analyzing system pressures. Testing may be conducted on Orifice tube system with cycling compressor systems, Expansion Valve (TXV) systems, and Orifice tube system with constant running compressor systems.

Orifice tube system with cycling compressor: a system making use of a flooded evaporator, a capillary valve (orifice tube), and a defroster pressure switch on the low-pressure side.

Expansion Valve (TXV) system: a system making use of a thermostatic expansion valve assembly including a relief valve.

Orifice tube system with constant running compressor: a system making use of a capillary valve (orifice tube) and a variable-displacement compressor.

For additional information about DESCRIPTION OF COMPONENTS and PREPARING FOR DIAGNOSTICS refer to Dynamic diagnostics instructions [MANUSBB005]

From the MANUAL PROCEDURE, select DEVICES:



Rustehnika.ru

Rustehnika.ru

Then select DIAGNOSIS, the following screen will be displayed:

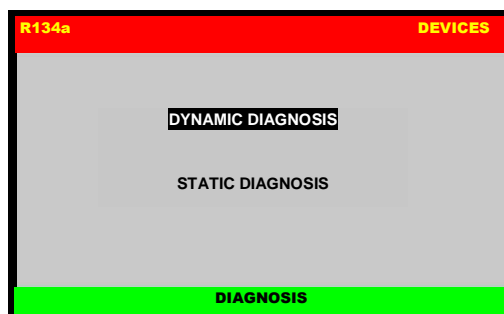

Select DYNAMIC DIAGNOSIS, the following screen will be displayed:

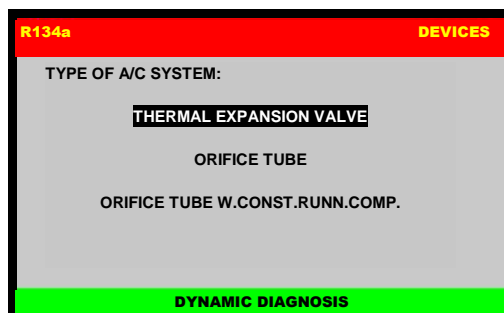

select the A/C system type and press OK

NOTE: Incorrect selection of A/C system type may falsify diagnostic results.

The following screen will be displayed:

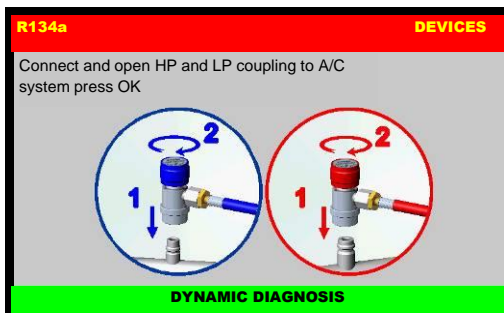

Connect and open HP and LP coupling to A/C system, then press OK to continue; the following screen will be displayed:

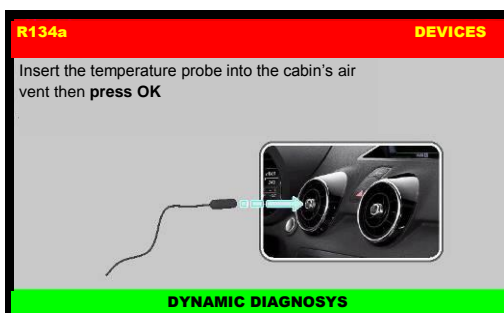

Insert the temperature probe into the cabin's air vent then press OK:

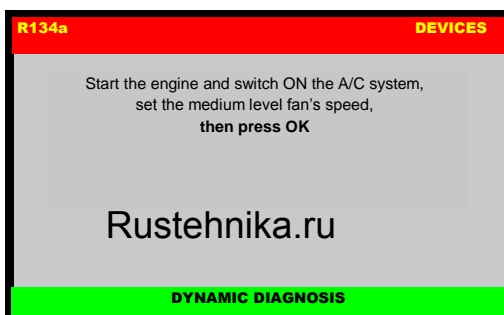

Rustehnika.ru

Rustehnika.ru

Start the engine and switch ON the A/C system, set the medium level fan's speed, then press OK:

The following screen will be displayed:

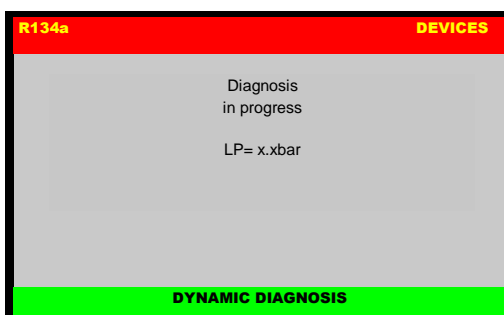

When the diagnosis routine is finished, the following screen will be displayed:

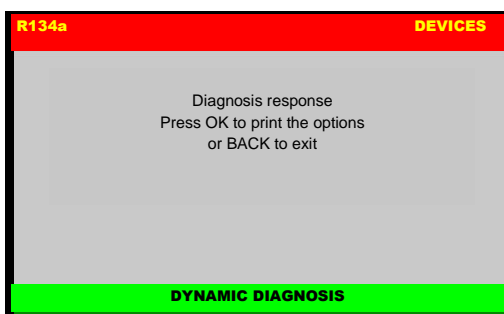

Press OK prints the options or BACK to exit.

IMPORTANT: The printout will list from one to three possible A/C system problems. Always begin with the first DIAGNOSIS shown and check the DIAGNOSIS in the order they are presented, making use of the REMEDIES listed under each DIAGNOSIS. Run the A/C system test again with the station after the first DIAGNOSIS item has been checked and/or repaired, in order to determine whether this repair is sufficient to solve the system problem. If not, go on to the next DIAGNOSIS/REMEDY, run the A/C system test again, and so on.

When diagnosis is completed and if SYSTEM OK is given, and if a recovery and recycling operation is not run, proceed as explained below to reintegrate the quantity of refrigerant present in the A/C system hoses:

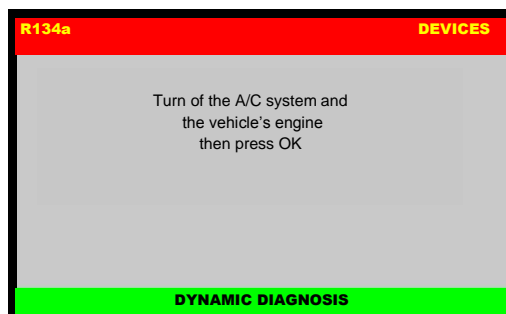

Turn of the A/C system and the vehicle's engine then press OK:



Rustehnika.ru

Rustehnika.ru

Unscrew HP coupling without disconnect from the A/C system, and press OK:

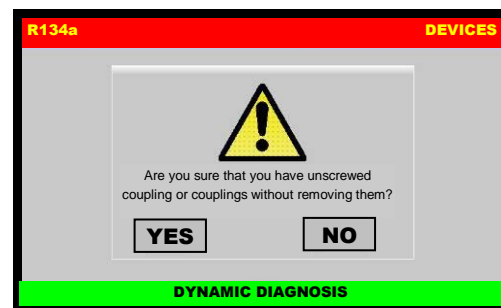

A pop-up message is displayed asking confirmation, press YES to continue:

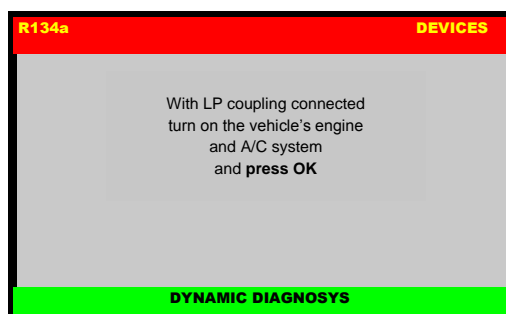

With LP coupling connected turn on the vehicle's engine and A/C system and press OK, after few moments the following screen will be displayed:

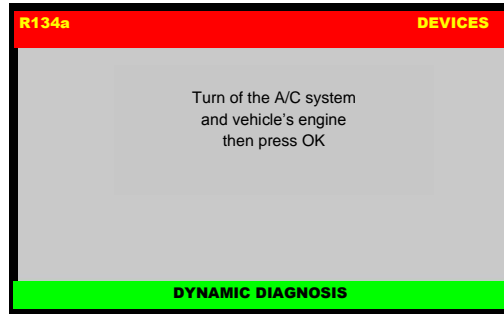

Turn of the A/C system and vehicle's engine then press OK:

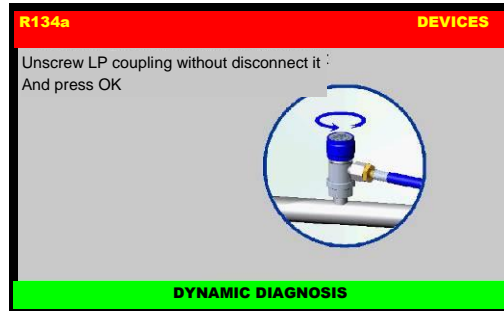

Unscrew LP coupling without disconnect it, and press OK:



Rustehnika.ru

Rustehnika.ru

A pop-up message is displayed asking confirmation, press YES to continue:

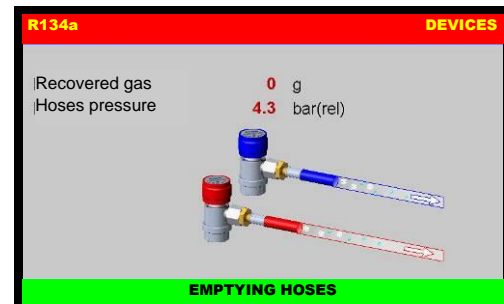

The machine will recover the residual refrigerant into the service hoses, then the following screen will be displayed:

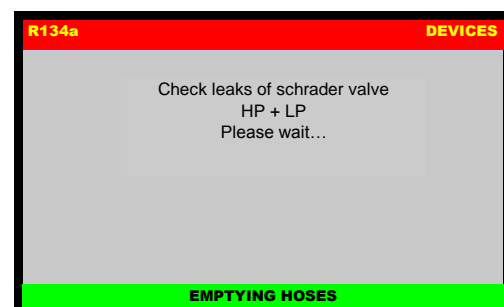

The machine will check if the Schrader valve of the coupling are tightened, then the following screen will be displayed:

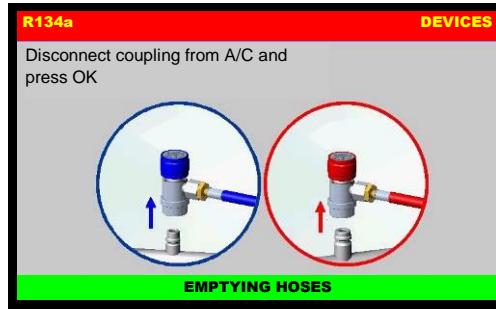

Disconnect coupling from A/C system.

Procedure is now successfully completed.

OPTIMUM CONDITIONS FOR A/C SYSTEM DIAGNOSTICS: Wind speed ca. 0 km/h. A/C fan set to second speed. A/C temperature control set to maximum cold. External (ambient) temperature from 21°C to 38°C. Engine at 1500 RPM for two minutes. Do not expose the vehicle to direct sunlight during diagnostic testing.

STATIC DIAGNOSIS^(optional)

NOTE: during STATIC DIAGNOSIS, it is not necessary connect the service hoses to the A/C system

From the MANUAL PROCEDURE, select DEVICES:

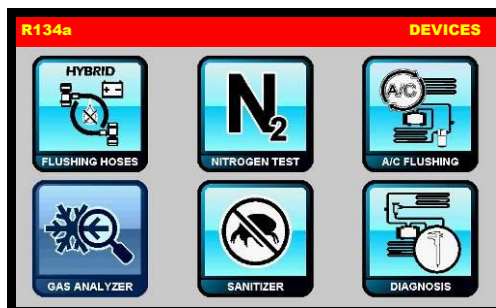

Then select DIAGNOSIS, the following screen will be displayed:

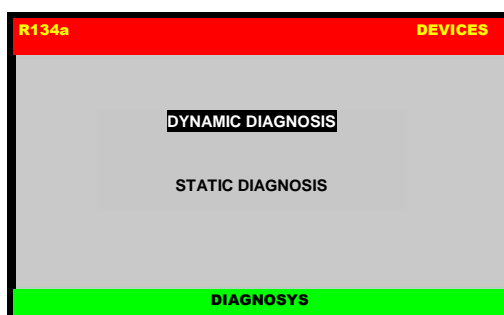

Select STATIC DIAGNOSIS, the following screen will be displayed

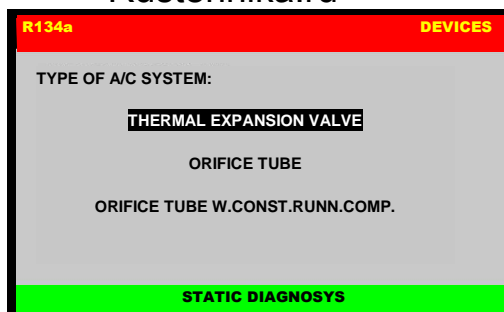

select the A/C system type and press OK

NOTE: Incorrect selection of A/C system type may falsify diagnostic results.

The following screen will be displayed:

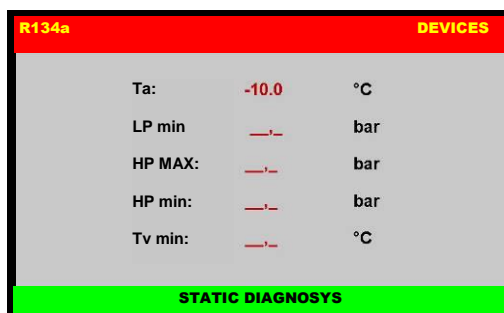

Type in, in order, the minimum value of low pressure, the maximum and minimum value of high pressure of the A/C system, and the temperature of the air at the outlet from the vents in the passenger compartment (use the thermometer supplied with the machine to measure).

Then press OK to confirm, the following screen will be displayed:

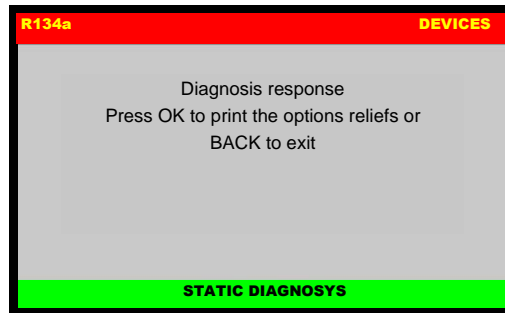

Press OK to print the diagnosis report: should the diagnosis results not be positive, the printout will list from one to three possible system problems. When checking, always start with the first DIAGNOSIS shown and check each in the order given, applying the REMEDIES listed for each DIAGNOSIS.

Retest the A/C system with the machine after the first DIAGNOSIS has been checked out and/or repaired, in order to determine whether or not the repair has solved the system problem. Retest after each DIAGNOSIS has been verified and/or the trouble repaired.

OPTIMUM CONDITIONS FOR A/C SYSTEM DIAGNOSTICS: Wind speed ca. 0 km/h. A/C fan set to second speed. A/C temperature control set to maximum cold. External (ambient) temperature from 21°C to 38°C. Engine at 1500 RPM for two minutes. Do not expose the vehicle to direct sunlight during diagnostic testing.

EXPRESS SERVICE

EXPRESS SERVICE is a programmable procedure similar to the automatic procedure but much faster (about 30 minutes of total running time).

From the MAIN MENU:



Select the EXPRESS SERVICE, the following screen is displayed (only if the hardware for hybrid vehicles is installed in the machine):

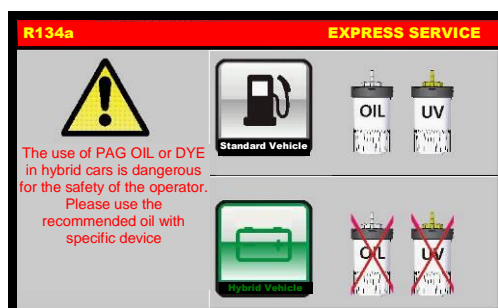

Select the STANDARD VEHICLE or HYBRID VEHICLE; the following screen will be displayed:

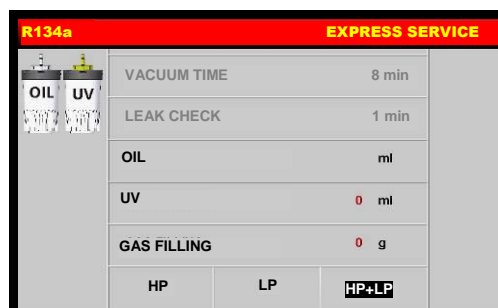

NOTE: When HYBRID VEHICLE is selected UV is disabled.

NOTE: VACUUM TIME and LEACK CHECK have fixed value (not modifiable)

Use arrows to scroll through menu items, then use the keypad to modify procedure parameters; press OK to begin the EXPRESS SERVICE.

From this point onwards refer to automatic procedure paragraph.

SETUP

From the MAIN MENU:



Select the SETUP, the following screen will be displayed:

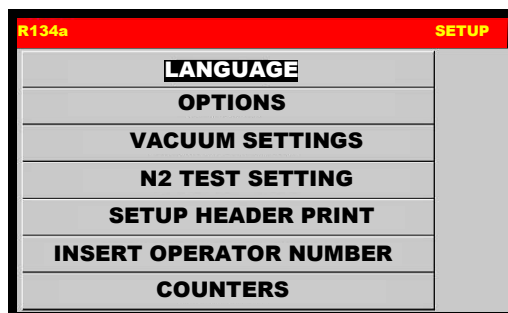

LANGUAGE

Rustehnika.ru

Rustehnika.ru

Rustehnika.ru

From the SETUP, select LANGUAGE :



NOTE: current language is indicated by black background

Select a language, then press OK to confirm.

OPTIONS

From the SETUP MENU, select OPTIONS and the following screen is displayed:

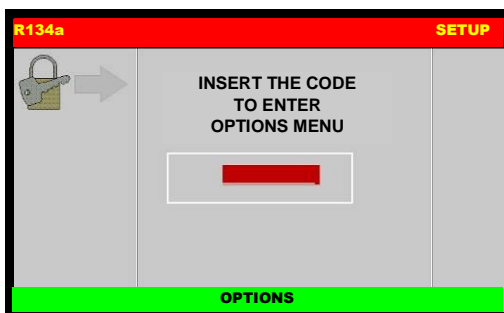

Enter the code **43210791** then press OK, the following screen will be displayed:

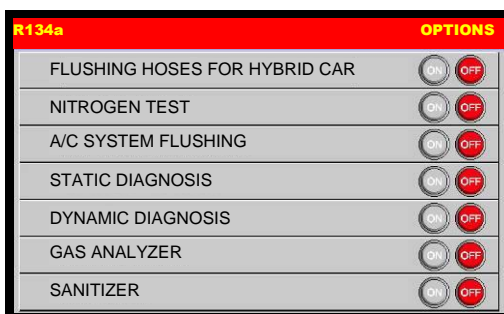

Press ↓ ARROW to scroll the options or change page:

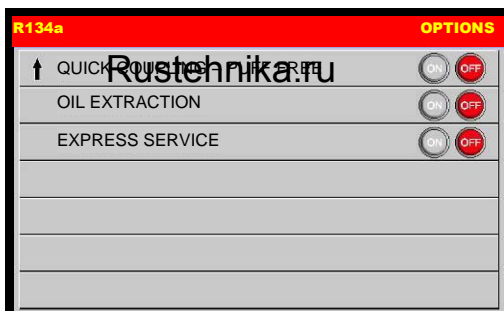

Press OK to select an option, the following screen will be displayed:

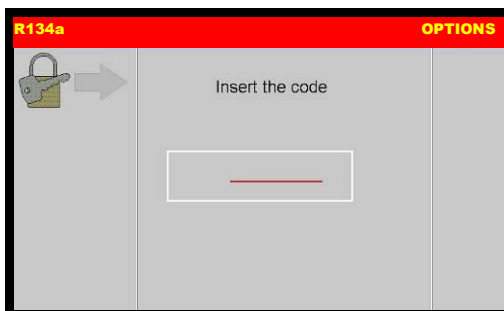

Type the enabler code (retrieved within the option kit) and press OK to enable the option. If the enabler code is not available, call the Service Center.

NOTE: EXPRESS SERVICE doesn't need the enabler code.

VACUUM SETTINGS

Allows to modify the default vacuum time and the default time of check.

From the SETUP, select VACUUM SETTINGS, default setting is displayed:

VACUUM SETTINGS	
Pressing INFO set default values	
Vacuum Time (min 1, max 120 Min.)	10 min.
Time of check (min 1, max 120 Min.)	1 min.
Vacuum rising (min 0.1, max 0.9 bar)	0.1 bar

Each value can be modified, within the values shown in parentheses.

NOTE: press INFO to restore default values:

- Vacuum time 25 min
- Time of check 2 min
- Vacuum rising 0,1 mbar

N2 TEST SETTINGS

From the SETUP, select N2 TEST SETTINGS, default setting is displayed:

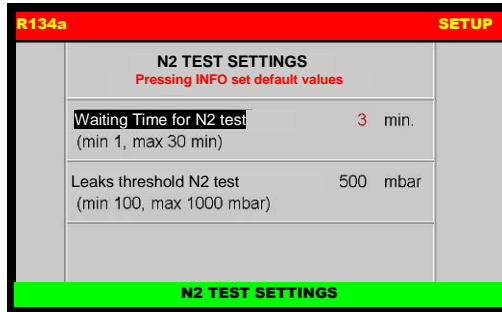

Each value can be modified, within the values shown in parentheses.

NOTE: press INFO to restore default values:

- Waiting time 2 min
- Leaks threshold 500mbar

SETUP HEADER PRINT

The printout can be personalized by entering 4 lines containing the workshop's details (e.g. Name, address, telephone n° and e-mail).

From the SETUP, select SETUP HEADER PRINT:

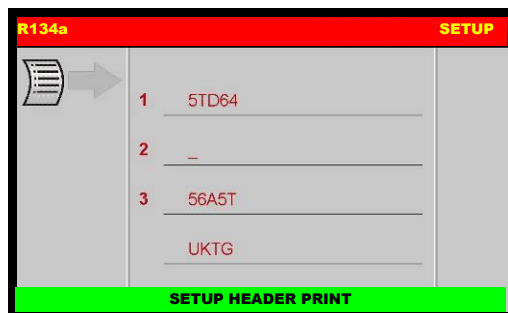

Use the keypad to modify the 4 lines, then press BACK to return to SETUP menu.

NOTE: the numerical keys include an alphabet that is used similar to text messaging; for example: press "2" once to display "A", twice to display "B", three time for "C", four time for "2"

INSERT OPERATOR NUMBER

From the SETUP, select INSERT OPERATOR NUMBER:

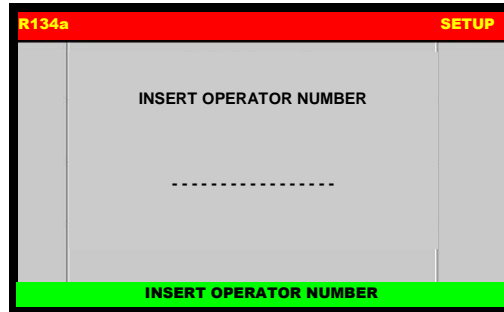

It is possible to enter an alphanumeric code of 10 symbols to indicate the habilitation nr of the operator. This number will be indicated in all printouts.

Use the keypad to modify operator number, then press OK to return to SETUP menu.

COUNTERS

This is used to check total COUNTERS of: recovered gas, service alarm meter, total vacuum minutes, injected gas, gas recovered into the bottle with the bottle refilling function.

From the SETUP MENU, select COUNTERS, the following screen is displayed:

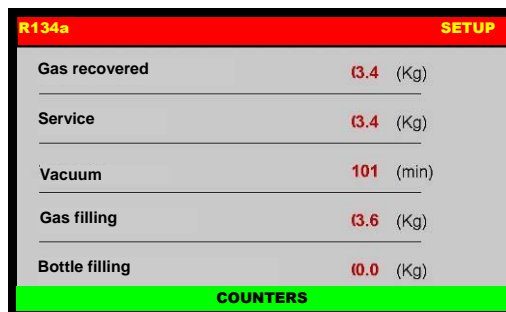

The screenshot shows a menu titled 'R134a SETUP' with a red header. Below the header, there are five rows of data, each with a label, a value, and a unit. The values are displayed in red. At the bottom of the screen, there is a green bar with the word 'COUNTERS' in white.

R134a		SETUP
Gas recovered	3.4	(Kg)
Service	3.4	(Kg)
Vacuum	101	(min)
Gas filling	3.6	(Kg)
Bottle filling	0.0	(Kg)

COUNTERS

This screen displays the total values for: gas recovered, service alarm COUNTERS, total vacuum time (minutes), gas injected, gas recovered in the internal bottle using the “Bottle filling” function.

SET DATE / TIME

The machine keeps date and time settings even if it is not used for around one year.

From the SETUP MENU, select SET DATE / TIME:



Use ARROW and keypad to change date and time, press OK to confirm, or press BACK to return to SETUP menu without saving the changes.

For example, to insert the date January 21st 2013, use ↓ ARROW to select the day then type “21” using the keypad, use → ARROW to select the month then type “2” using the keypad, use → ARROW to select the year then type “2013” using the keypad; press OK to confirm and exit.

OIL SETTINGS

From the SETUP MENU, select OIL SETTINGS:

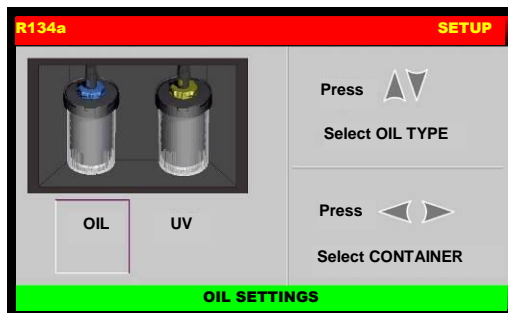

Use $\uparrow\downarrow$ ARROW to select OIL TYPE, use $\leftarrow\rightarrow$ ARROW to select CONTAINER, press OK to confirm.

NOTE: this operation is to use different containers, for example, if instead of a UV you want to use a HYBRID UV: use \rightarrow ARROW to select UV CONTAINER, the press \downarrow ARROW to select HYBRID UV; then press OK to confirm

MAINTENANCE

From the MAIN MENU:



Select the MAINTENANCE, the following screen will be displayed:

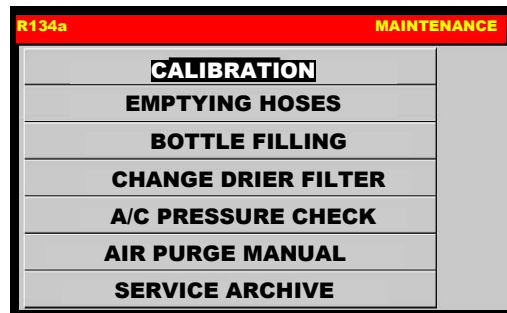

CALIBRATION

N.B. This menu is reserved for use by the technician performing final testing. It contains the maximum safety threshold value; therefore, the bottle data may not be changed for any reason. For assistance, call the Service Center.

Perform this operation whenever the values displayed on display do not correspond to real values.

WARNING: The operations listed below must be performed with maximum attention and care. In particular, always observe the following precautions.

Always place the weights at the center of the scale plate. Never exert pressure on the oil scale.

Always recover the gas in the high- and low-pressure hoses before beginning calibration of the transducers.

Select the CALIBRATION, the following screen is displayed:

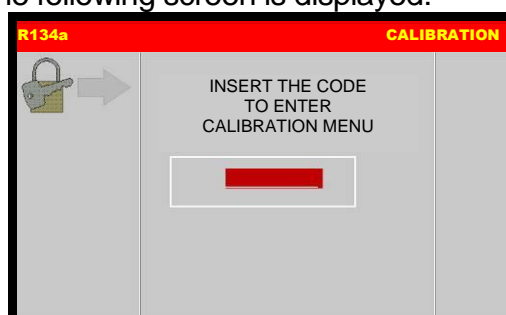

Type the code **0791** and press OK to confirm, the following screen will be displayed:

Rustehnika.ru

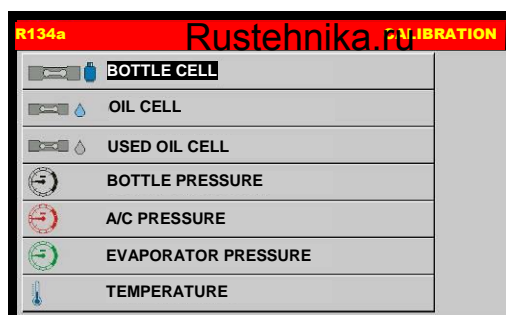

Rustehnika.ru

BOTTLE CELL

If you have not changed the load cell or motherboard you can restore the calibration (refer to RESTORE CALIBRATION paragraph)

Disconnect the machine from the electrical supply.

Procure a known reference weight from 28 to 30 kg.

remove the rear plastic (ref 2, Fig.13) cover to access the machine bottle.

Unscrew the bottle lock nut (ref 1, Fig.14).

Separate the heating coil (ref 2, Fig.14) from the bottle (do not touch or disconnect the wires of the resistance coil).

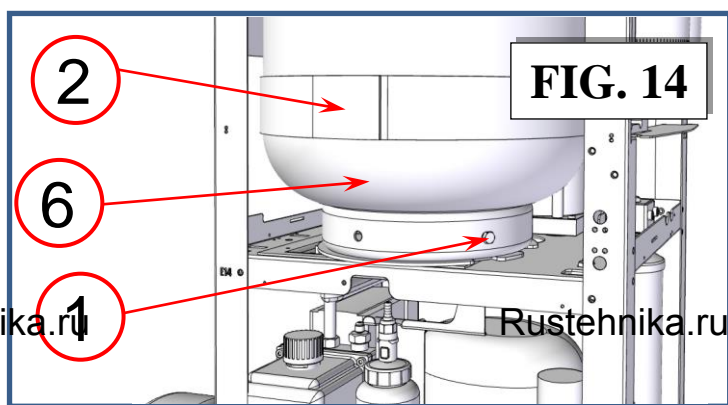
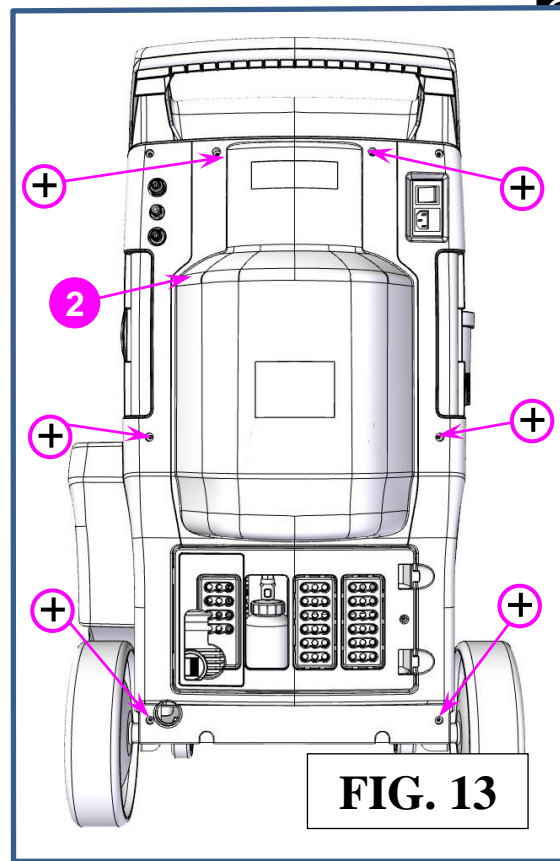

Rustehnika.ru

Rustehnika.ru

Rustehnika.ru

Close the red tap of the bottle (ref 7, Fig.15) and blue tap of the bottle (ref 8, Fig.15)

Close the tap of the red hose (ref 3, Fig.15) and of the blue hose (ref 4, Fig.15), then disconnect them from the bottle.

Close the tap of the capillary hose (ref 5, Fig.15) then disconnect it from the bottle.

Remove the bottle (ref 6, Fig.14) from its lodging, leaving the resistance around the scale plate.

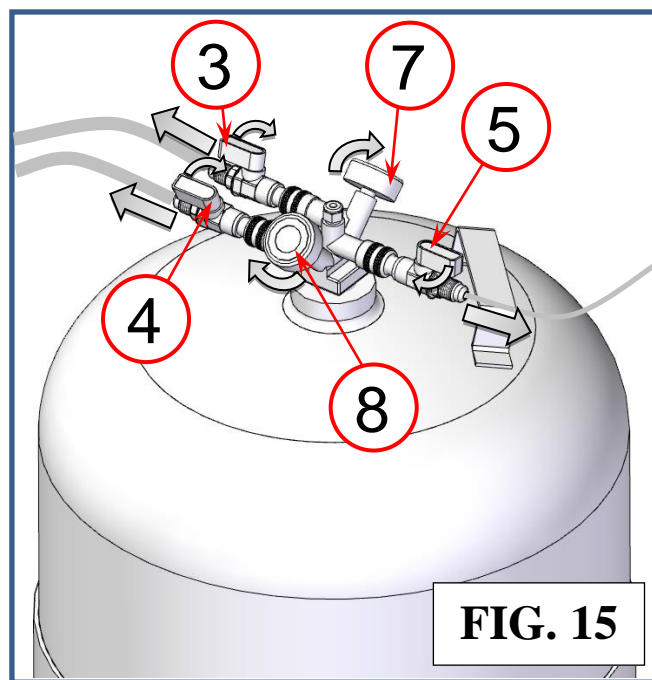

From CALIBRATION, select BOTTLE CELL, the following screen is displayed:



- With the bottle lifted off the scale plate, use ARROW to select Min, verify that the value is 0 g (otherwise use the keypad) then press OK to confirm Min.
- Place the reference weight (28 to 30 kg) at the center of the scale plate. use keys 0 through 9 to type in the value of the weight; press OK to confirm MAX.
- Remove the reference weight, then verify the correct reading of the scale, adding and removing different reference weights.
- Select the Tare, use keys 0 through 9 to type in the value of the tare (depending on machine model: 9500 g for 22l R134a bottle or 5800 g for 12l R1234yf bottle); then press OK to confirm Tare.

Press BACK to exit to CALIBRATION MENU

Switch off the machine and disconnect it from mains supply.

Replace the bottle (ref 6, Fig.16) on the scale plate and the heating coil (ref 2, Fig.16) on the bottle (Attention: the resistance must adhere tightly to the bottle).

Screw the bottle lock nut (ref 1, Fig.16).

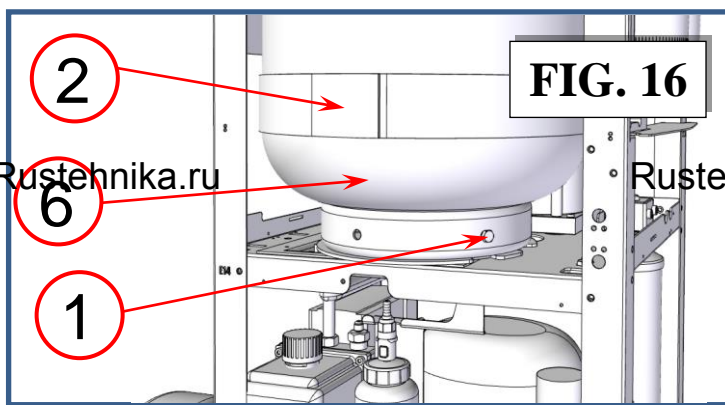

Connect red and blue hoses to the bottle, then open the tap of the red hose (ref 3, Fig.17) and of the blue hose (ref 4, Fig.17),

Connect the capillary hoses to the bottle, then open the tap of the capillary hose (ref 5, Fig.17).

Open the red tap of the bottle (ref 7, Fig.17) and blue tap of the bottle (ref 8, Fig.17)

Replace plastic covers.

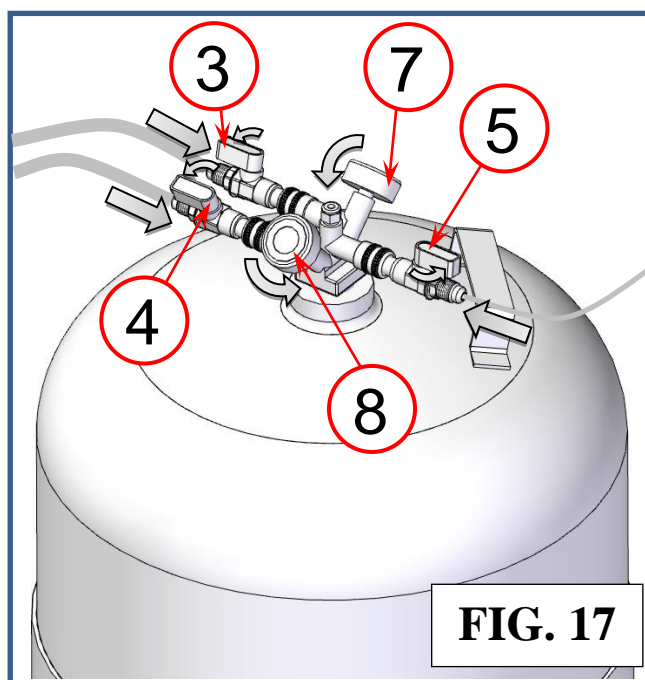

NOTE: To get an accurate value of the tare this should be weighed with the empty bottle mounted on the plate (tare value can vary from a few grams, depending on the positioning of the bottle and the tubing connected to it), but it is not always possible or easy empty it. The value of the tare does not compromise the correct functioning of the cell but simply move the value "0" reference distorting the availability of a few grams of refrigerant present in the bottle

OIL CELL

If you have not changed the load cell or motherboard you can restore the calibration (refer to RESTORE CALIBRATION paragraph)

From CALIBRATION, select OIL CELL:

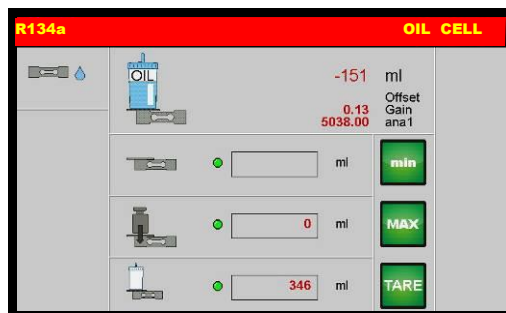

- Remove container from its lodgings, taking care not to exert pressure on the scale,
- Select Min verify that the value in the textbox Min is 0 ml (otherwise use the keypad) then press OK to confirm Min.
- Put in the slot of the container a known weight that varies from 100 to 200 grams
- Use keys 0 through 9 to type in the value in ml by adding 4% (for example, if the weight is 100 grams write 104 ml), then press OK to confirm MAX.
- Replace the empty container in place and ensure that the amount is 0 ml, otherwise modify the value of the tare, use keys 0 through 9 to type in the value of the tare (usually approximately 150g); then press OK to confirm Tare
- Verify the correct reading of the scale, adding and removing a reference weight (100g correspond to 104ml).

Switch off the machine and disconnect it from the electrical supply.

NOTE: To get an accurate value of the tare this should be weighed with the empty oil container mounted on the plate (tare value can vary from a few grams, depending on the positioning of the oil container and the tubing connected to it). Insert 150 g does not compromise the correct functioning of the cell but simply move the value "0" reference distorting the availability of a few grams of oil present in the container.

USED OIL CELL

If you have not changed the load cell or motherboard you can restore the calibration (refer to RESTORE CALIBRATION paragraph)

From CALIBRATION, select USED OIL CELL:

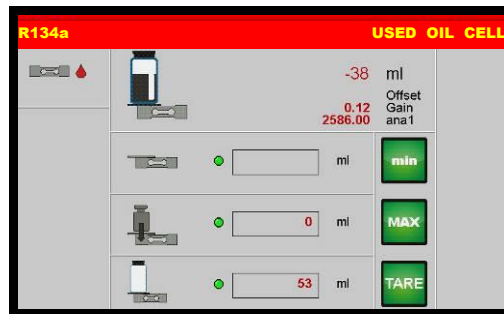

- Remove container from its lodgings, taking care not to exert pressure on the scale, Select Min verify that the value in the textbox Min is 0 ml (otherwise use the keypad) then press OK to confirm Min.
- Put in the slot of the container a known weight that varies from 100 to 200 grams
- Use keys 0 through 9 to type in the value in ml by adding 4% (for example, if the weight is 100 grams write 104 ml), then press OK to confirm MAX.
- Replace the empty container in place and ensure that the amount is 0 ml, otherwise modify the value of the tare, use keys 0 through 9 to type in the value of the tare (usually approximately 150g); then press OK to confirm Tare
- Verify the correct reading of the scale, adding and removing a reference weight (100g correspond to 104ml).

Rustehnika.ru

Rustehnika.ru

Rustehnika.ru

Switch off the machine and disconnect it from the electrical supply.

NOTE: To get an accurate value of the tare this should be weighed with the empty oil container mounted on the plate (tare value can vary from a few grams, depending on the positioning of the oil container and the tubing connected to it). Insert 150 g does not compromise the correct functioning of the cell but simply move the value "0" reference distorting the availability of a few grams of oil present in the container.

BOTTLE PRESSURE

From CALIBRATION, select BOTTLE PRESSURE, the following screen is displayed:



Press OK, the following warning message is displayed:

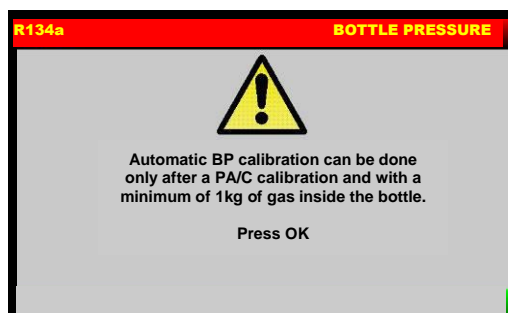

ATTENTION: Automatic Bottle Pressure calibration can be done only if A/C Pressure is calibrated and with a minimum of 1 kg of gas inside the bottle.

Press OK to continue:

Rustehnika.ru



Rustehnika.ru

Close the red bottle valve (ref 7, Fig.17), then press OK:



Make sure that HP and LP couplings are disconnected from A/C system or else, then press OK to continue:

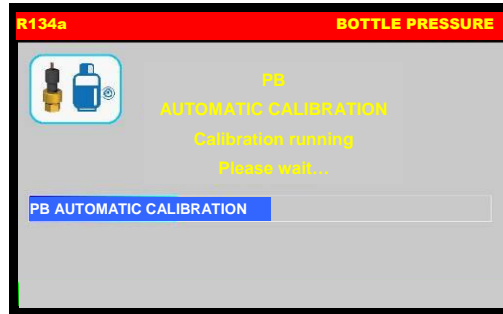

After few minutes the following message will be displayed:

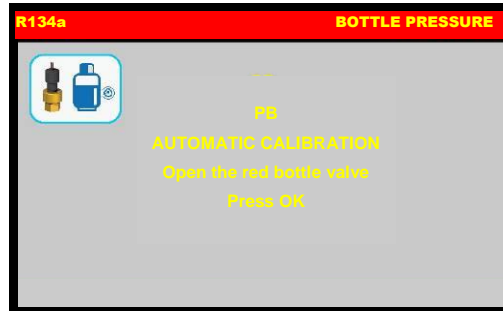

Open the red bottle valve, then press OK:

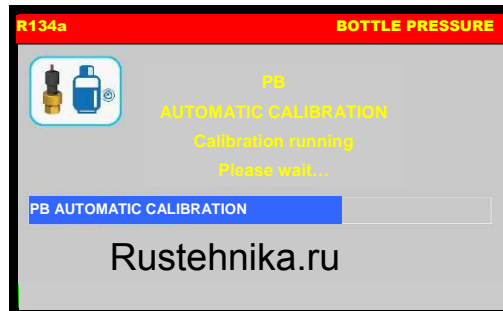

Rustehnika.ru

Rustehnika.ru

After few minutes the following message will be displayed:



BOTTLE PRESSURE calibration successfully completed, Press OK return exit.
Switch off the machine and disconnect it from the electrical supply.

A/C PRESSURE

From CALIBRATION, select A/C PRESSURE, the following screen is displayed:

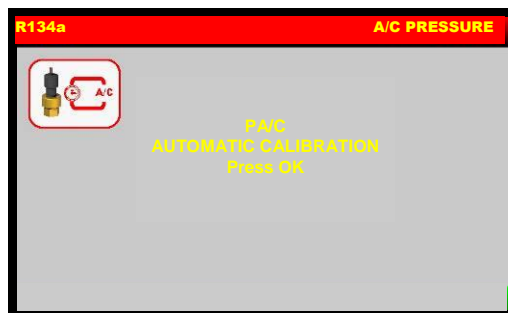

Press OK, the following warning message is displayed:



Make sure that HP and LP couplings are disconnected from A/C system or else, then press OK to continue:

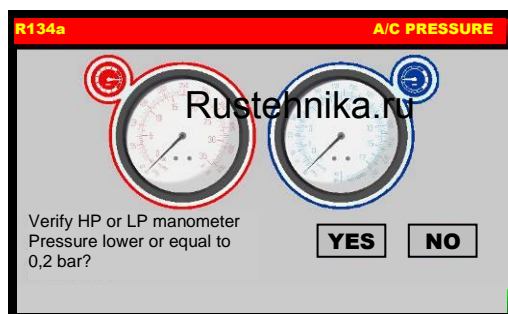

Rustehnika.ru

Rustehnika.ru

Verify on HP or LP manometer if the pressure is LOWER or equal to 0,2 bar.

Press NO to run a quick emptying hoses, press YES to continue, the following message is displayed:

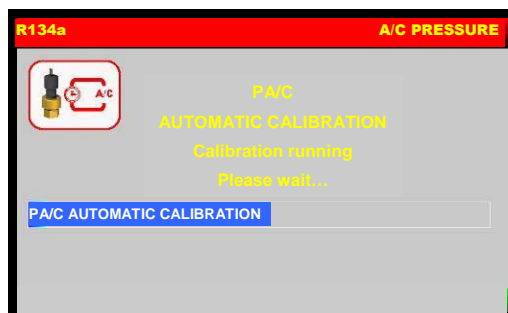

After few minutes the following message will be displayed:



A/C PRESSURE calibration successfully completed, Press OK return exit.
Switch off the machine and disconnect it from the electrical supply.

EVAPORATOR PRESSURE

From CALIBRATION, select EVAPORATOR PRESSURE, the following screen is displayed:



Press OK, the following warning message is displayed:

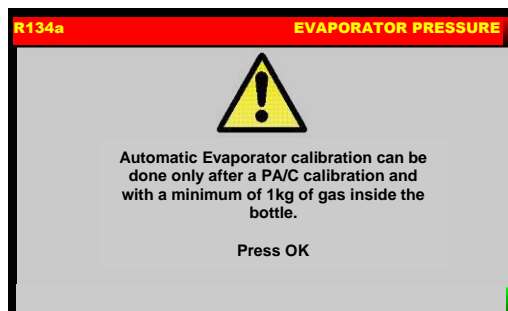

ATTENTION: Automatic Evaporator Pressure calibration can be done only if A/C Pressure is calibrated and with a minimum of 1 kg of gas inside the bottle.

Press OK to continue:

Rustehnika.ru



Rustehnika.ru

Make sure that HP and LP couplings are disconnected from A/C system or else, then press OK to continue:

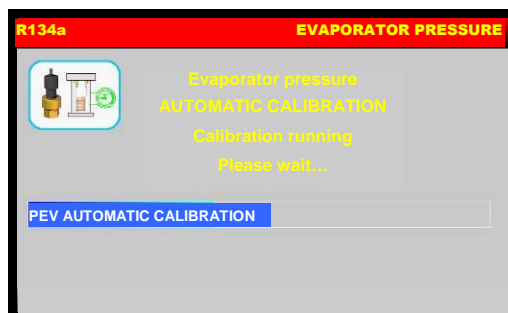

After few minutes the following message will be displayed:



EVAPORATOR PRESSURE calibration successfully completed, Press OK return exit.
Switch off the machine and disconnect it from the electrical supply.

TEMPERATURE

NOTE: A digital thermometer is required for bottle temperature sensor calibration.

From CALIBRATION, select TEMPERATURE, the following screen is displayed:

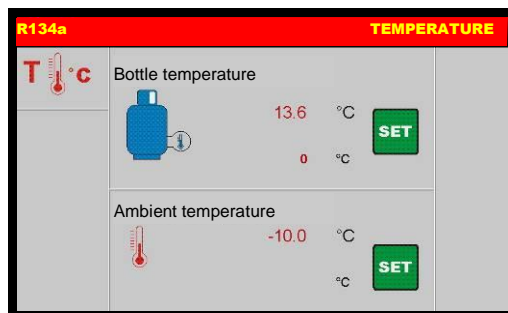

Bottle Temperature

If you have not changed the sensor or motherboard you can restore the calibration (refer to RESTORE CALIBRATION paragraph)

Check that the bottle temperature probe is disconnected from the bottle and so capable of reading the ambient temperature.

Check that the temperature shown on the display is that also read on the external thermometer. If necessary use ARROW to select SET button of bottle temperature, then use keys 0 through 9 to type in the value read on the external thermometer; then press OK to confirm.

Replace the temperature probe on the bottle.

Ambient Temperature

If you have not changed the sensor or motherboard you can restore the calibration (refer to RESTORE CALIBRATION paragraph)

Check that the temperature shown on the display is that also read on the external thermometer. If necessary use ARROW to select SET button of ambient temperature, then use keys 0 through 9 to type in the value read on the external thermometer; then press OK to confirm.

RESTORE CALIBRATION

If none of these components has been replaced, pressure transducer Pa/c, Pev, Pb, bottle load cell, new oil load cell, used oil load cell. You can restore the factory calibration

From CALIBRATION, select RESTORE CALIBRATION, the following screen is displayed:



Press OK to restore factory calibration.

EMPTYING HOSES

From MAINTENANCE , select EMPTYING HOSES, the following screen will be displayed:

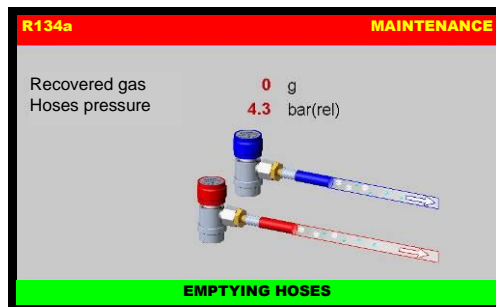

the machine will recover all the refrigerant into the service hoses; then the machine will sound and alarm and the following screen will be displayed:

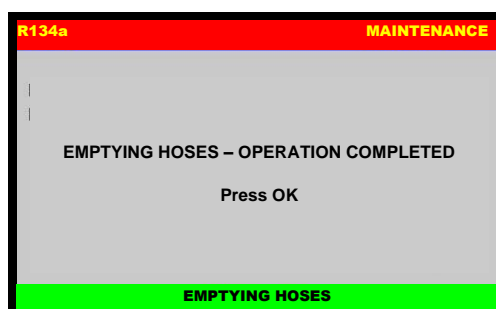

Press OK to return to the MAINTENANCE MENU; EMPTYING HOSES is now successfully completed.

BOTTLE FILLING

This operation must be performed whenever the available refrigerant fluid in the bottle is less than 3 kg and must in any case be performed when the “empty bottle” alarm is displayed.

From MAINTENANCE, select BOTTLE FILLING, the following screen will be displayed:

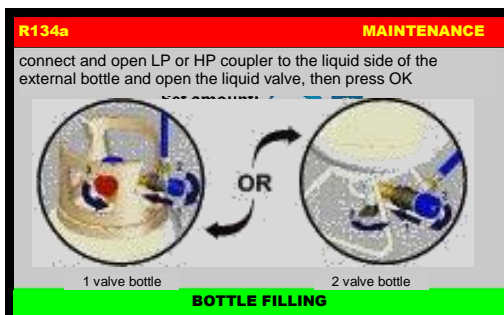

Procure a bottle of appropriate refrigerant (R134a or R1234yf depending on machine model), connect and open LP coupler to the liquid side of the external bottle and open the liquid valve, then press OK.

The following screen will be displayed:



Rustehnika.ru

Rustehnika.ru

Use the keypad to insert the amount of refrigerant, then press OK to continue.

The BOTTLE FILLING will start

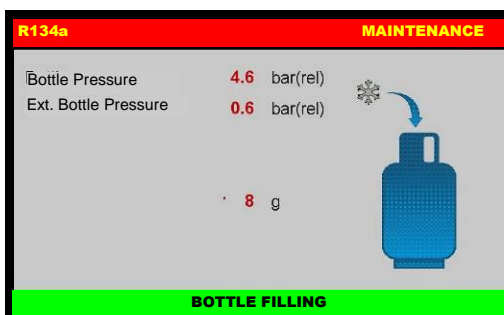

the machine will now fill the machine bottle with the preset quantity ~ 500g. When the quantity minus 500 grams is reached, the machine will stop and display:

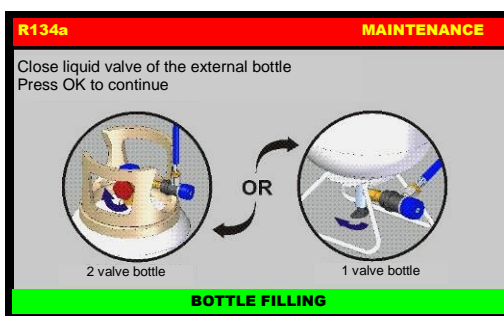

Close the liquid valve of the external bottle and press OK, the machine will recover the residual refrigerant from the hoses, then will display the following screen:

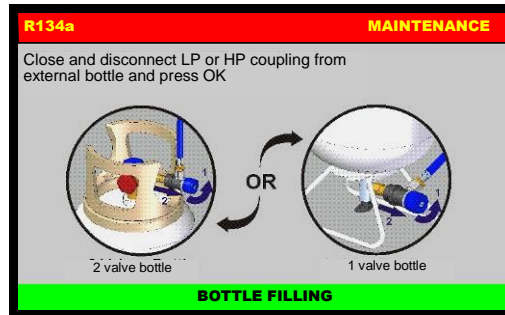

Close and disconnect LP coupling from external bottle and press OK.

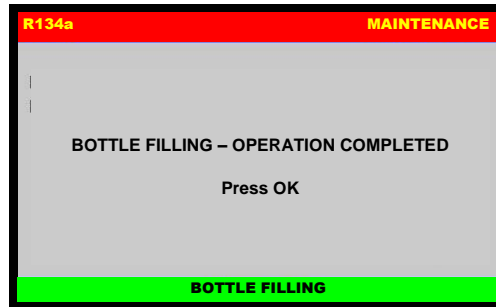

Bottle filling procedure successfully completed. Switch the machine off.

NOTE: if the external bottle is not supplied with a liquid side coupling, upend it to recover liquid refrigerant.

CHANGE DRYER FILTER

Replace the filter whenever the machine gives the service alarm signals the presence of humidity in the circuit.

Before performing any operation, check that the replacement filter is the same type as these installed on the machine.

Then proceed as described below:

- 1) **Wear protective gloves and glasses**
- 2) Connect the machine to the electrical supply and it turn on
- 3) Note down the release code on the new filters.

IMPORTANT: Filter replacement must be performed as quickly as possible in order to avoid possible contamination by moisture in the ambient air.

NOTE: If possible, check the seal on the couplings of the new filter, using an electronic leak tester.

- 4) From MAINTENANCE, select CHANGE DRYER FILTER, the following warning message is visualized:



An accidental leakage of refrigerant may cause serious damage to skin and eyes, wear protective gloves and goggles. Press OK to continue:

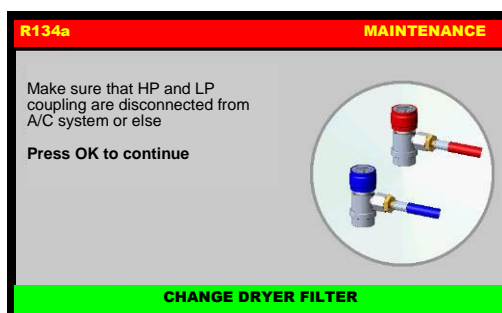

- 5) Make sure that HP and LP coupling are disconnected from A/C system or else and press OK, machine will check presence of refrigerant:



- 6) And if necessary will recover it

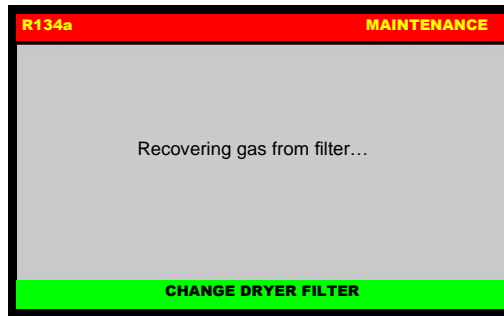

7) then the following screen is displayed:

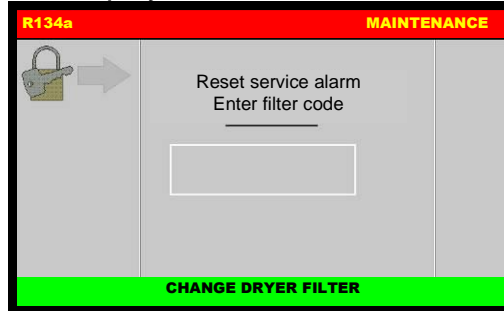

8) Type the filter code and press OK to delete the alarm. If the filter code is not available, call the Service Center:

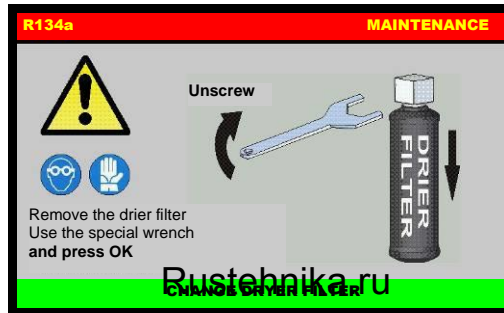

Rustehnika.ru

Rustehnika.ru

Rustehnika.ru

9) Remove the dryer filter, use the special wrench (ref Fig.18)

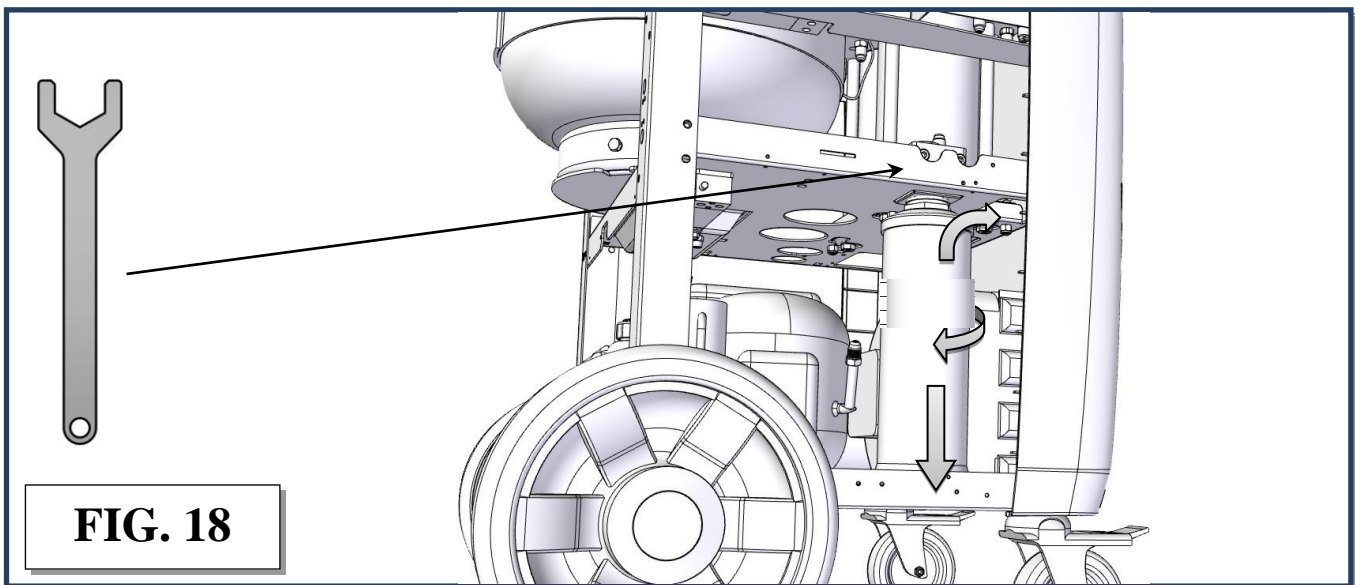

10) press OK to continue:

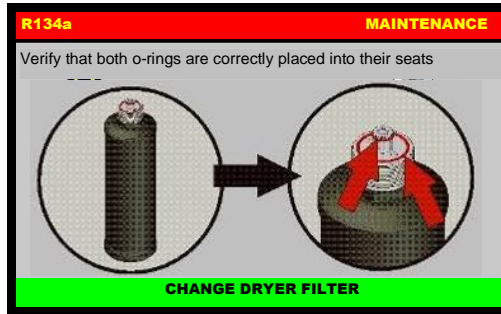

- 11) Take the new filter, wet with clean POE oil both o-rings, and verify that they are correctly placed into their seats, press OK:

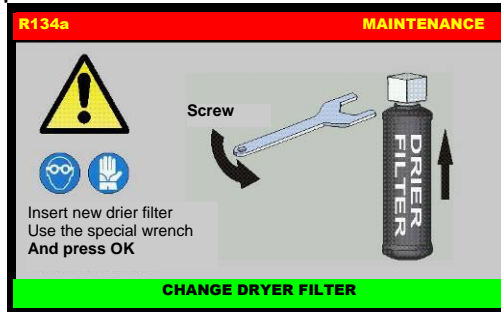

- 12) Insert the new dryer filter, use the special wrench (ref Fig.19),

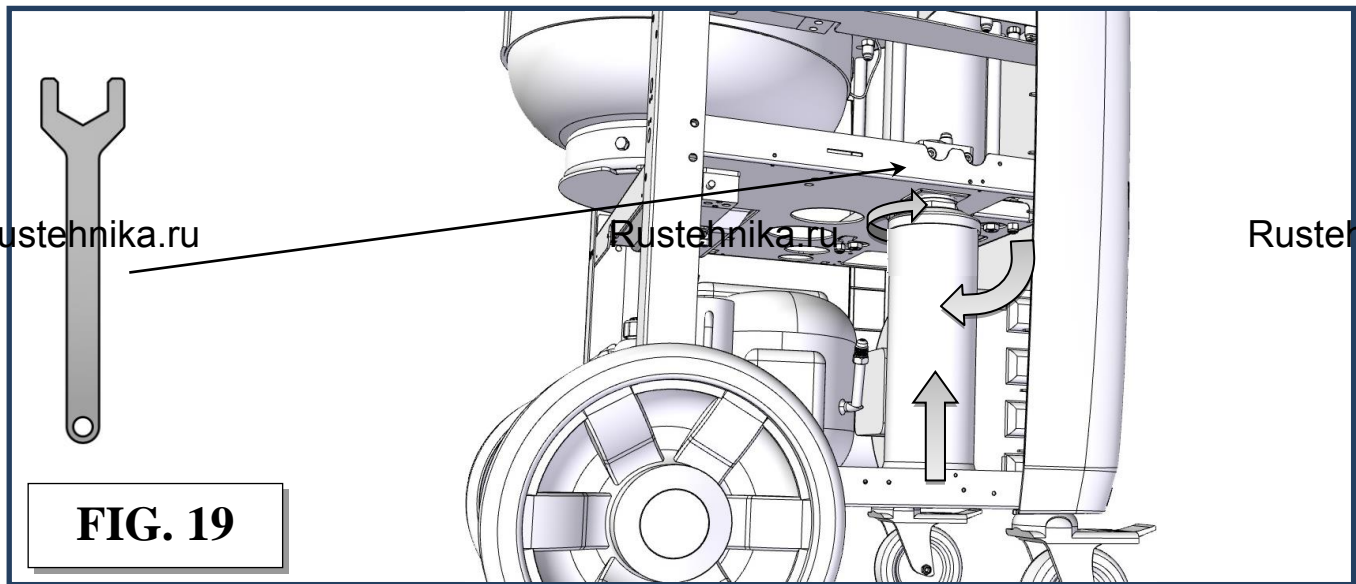

- 13) and press OK:

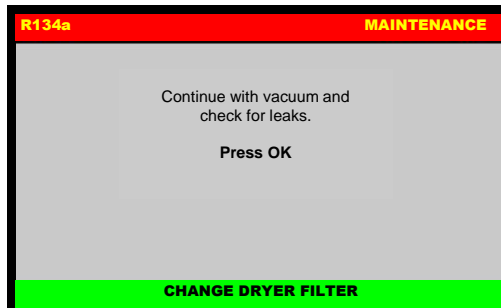

- 14) Press OK to continue with vacuum check:

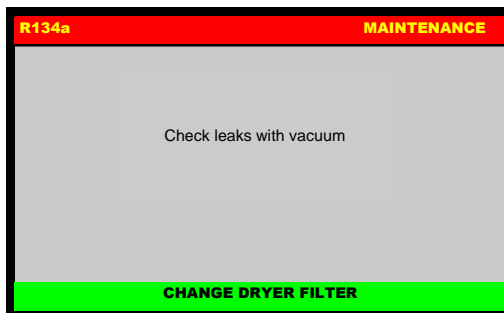

15) If leaks are detected the following screen will be displayed:

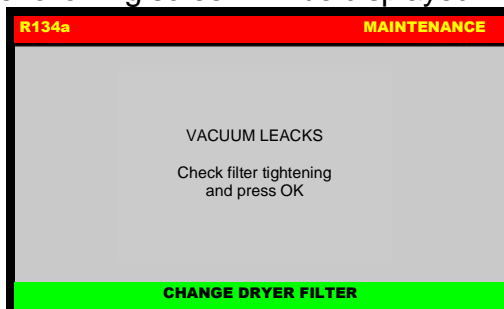

Check filter tightening and press OK to restart the vacuum check.

16) After few minutes, if no leaks are detected the following screen will be displayed:



Rustehnika.ru

Rustehnika.ru

Rustehnika.ru

17) If leaks are detected the following screen will be displayed:

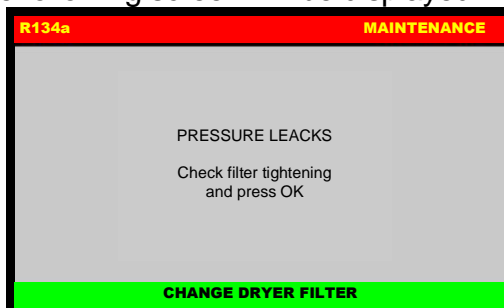

Check filter tightening and press OK to restart the pressure check.

18) If no leaks are detected the following screen will be displayed:

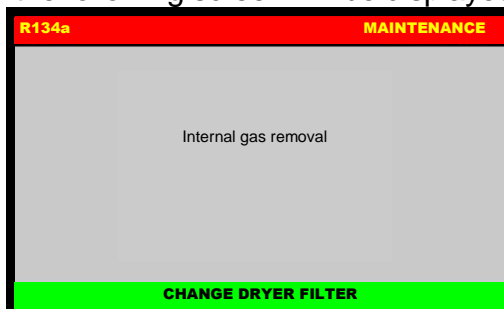

19) Then After few minutes:

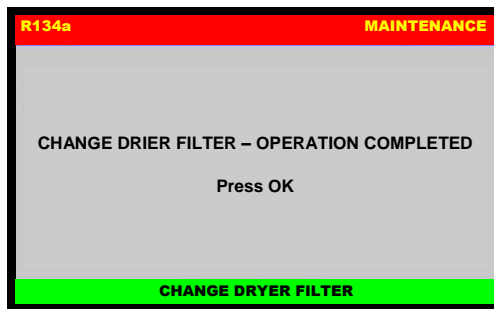

20) Press OK to return to the MAINTENANCE MENU; DRYER FILTER CHANGE is now successfully completed.

A/C PRESSURES CHECK

From MAINTENANCE select A/C PRESSURES CHECK, the following screen will be displayed:

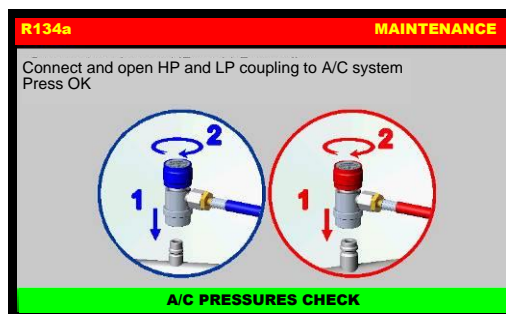

Connect and open the coupling connected to the A/C system, then press OK, press BACK to return back; the following screen is displayed:

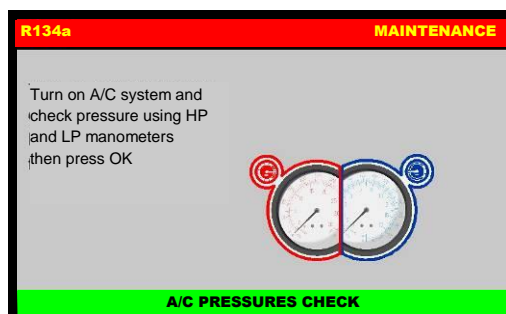

Turn on A/C system and check pressure using HP and LP manometers, then press OK: Rustehnika.ru

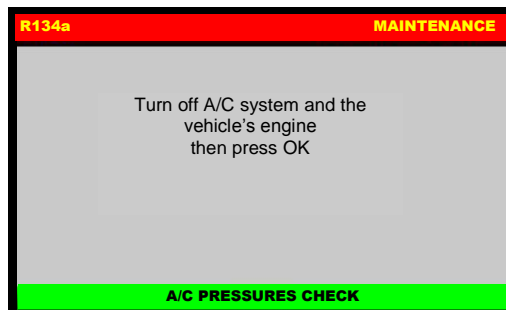

Turn off A/C system and the vehicle's engine, then press OK:

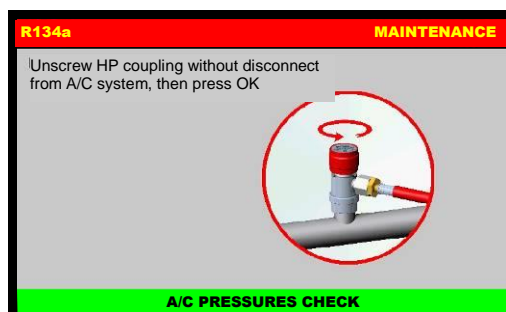

Unscrew HP coupling without disconnect it, then press OK:

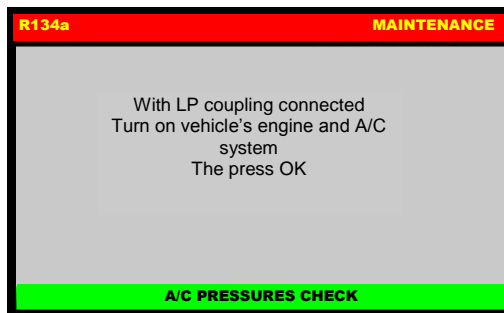

With LP coupling connected turn on the vehicle's engine and A/C system, then press OK:



The vehicle's A/C system will recover the refrigerant from the service hoses, then:

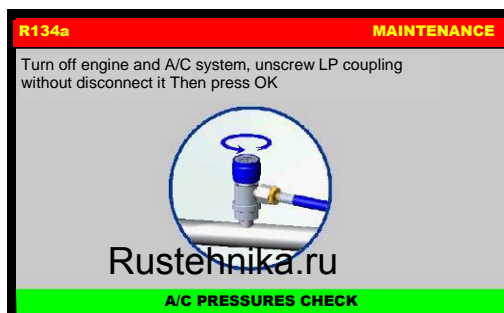

Rustehnika.ru

Rustehnika.ru

Turn off engine and A/C system, unscrew LP coupling without disconnect it, then press OK:

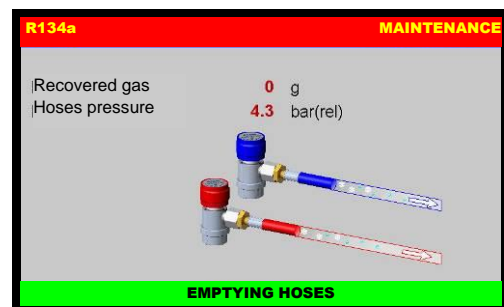

The machine will recover the residual refrigerant into the service hoses, then the following screen will be displayed:

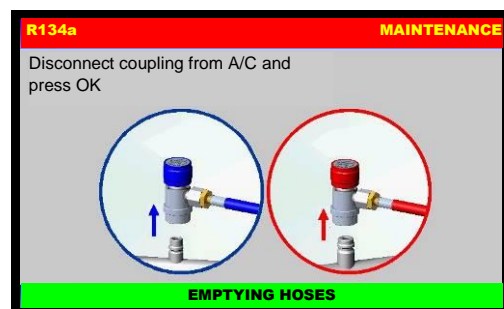

Disconnect coupling from A/C system, press OK to return to the MAINTENANCE MENU; A/C PRESSURES CHECK is now successfully completed.

AIR PURGE MANUAL

From MAINTENANCE, select AIR PURGE MANUAL, the following screen will be displayed:

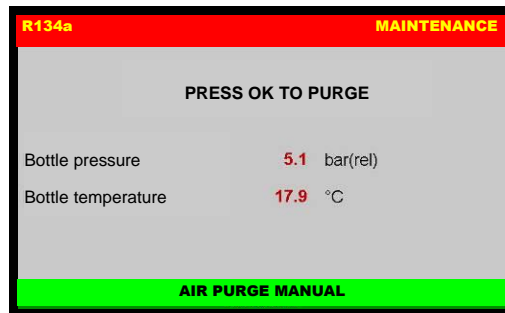

If “PRESS OK TO PURGE” is displayed, there is air in the bottle. In this case, press OK: the machine will begin discharging the air. Press STOP to pause the Air Purging process.

NOTE: If there isn't air into the bottle, the following message is displayed: AIR PURGE NOT NECESSARY

Press BACK to terminate the Air Purging process, and return to the MAINTENANCE menu.

SERVICES ARCHIVE

The machine keeps track of the operations done on refrigerant fluid: recovery, system refilling, inner bottle filling. For any operation, a record is made with date, time, type of operation, quantities involved, operator nr., inner bottle refrigerant fluid availability.

From the MAINTENANCE, select SERVICE ARCHIVE

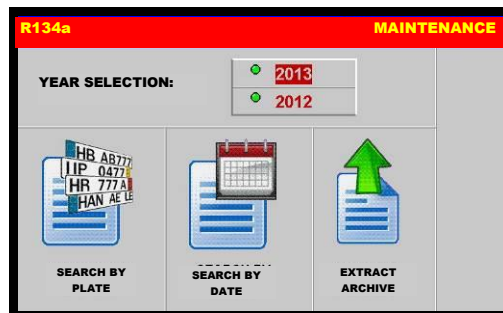

SEARCH BY PLATE

Selecting SEARCH BY PLATE, the following screen will be displayed:



Rustehnika.ru

Rustehnika.ru

Use the keypad to insert plate number to search, then press OK:

Plate:	Time:	Date:
1423A2422 343	17:53	30/02/2014
35A085 852	17:43	31/01/2013
-	-	-
-	-	-
-	-	-
-	-	-

A list will be displayed, select service for detailed info:

R134a MAINTENANCE	
Plate:	35A085 852
Time:	17:43
Date:	31/01/2013
Recovered gas:	49 g
Injected gas:	0 g
Recovered oil:	0 ml
Injected oil:	0 ml Oil type:
Injected die:	0 ml
Vacuum time:	5 min Leak test:
Vacuum reached:	4.9 mbar

Press OK to print the report of the service, or press BACK to return to previous menu.

SEARCH BY DATE

Selecting SEARCH BY DATE, the following screen will be displayed:

Use the arrows to insert date to search, then press OK:

Plate:	Time:	Date:
1423A2422 343	17:53	30/02/2014
35A085 852	17:43	31/01/2013
-	-	-
-	-	-
-	-	-
-	-	-
-	-	-

A list will be displayed, select service for detailed info:

Plate: 35A085 852
Time: 17:43
Date: 31/01/2013

Recovered gas: 0 g
Injected gas: 0 g
Recovered oil: 0 ml
Injected oil: 0 ml **Oil type:**
Injected die: 0 ml
Vacuum time: 5 min **Leak test:**
Vacuum reached: 4.9 mbar

Press OK logo to print the report of the service, or press BACK to return to previous menu.

EXTRACT ARCHIVE

Selecting EXTRACT ARCHIVE, the following screen will be displayed:

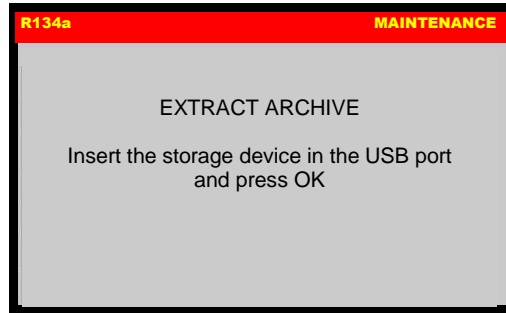

Insert the storage device in the USB port and press OK, to save to copy a TXT file with all the operations into the Pendrive.

The following screen will be displayed for few seconds:

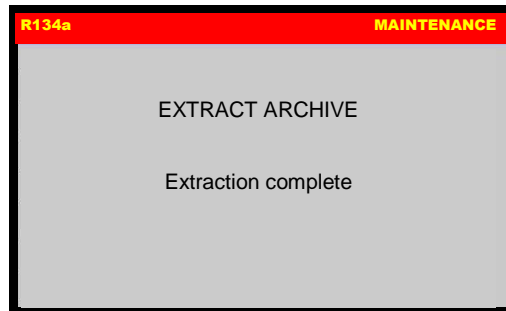

Extraction is now completed, the machine will return to the previous menu

CHANGE OIL/UV CONTAINER

This procedure is needed when changing oil, to remove traces of previous oil from the pipeline.

From MAINTENANCE, select CHANGE OIL/UV CONTAINER, the following screen will be displayed:

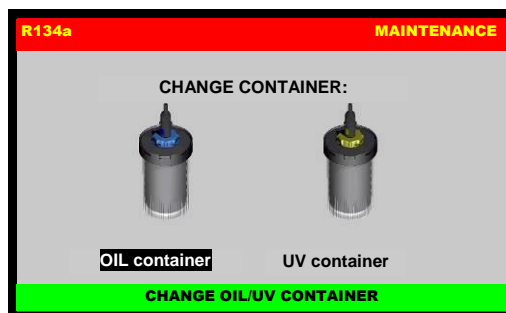

Select container to substitute, then press OK, the following screen will be displayed:

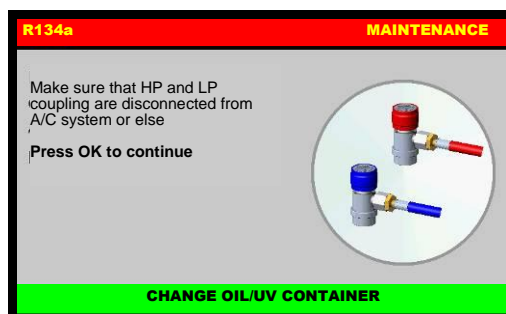

Make sure that HP and LP coupling are disconnected from A/C system or else and press OK.



Remove the old container and replace it with the newer one already filled, then press OK to begin oil drain procedure, the following screen will be displayed:

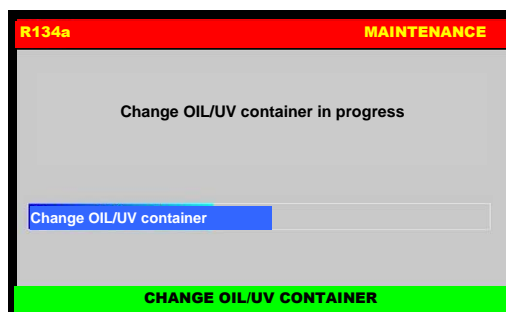

After some minutes, at the end of the operation the following screen will be displayed:

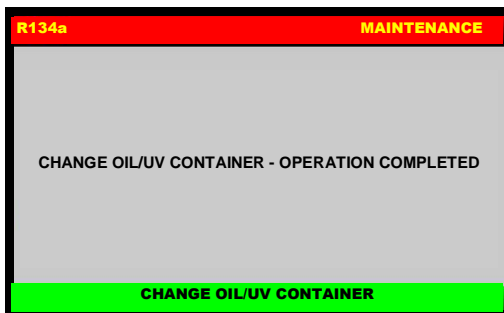

Press OK to return to the MAINTENANCE MENU; CHANGE OIL/UV CONTAINER is now successfully completed.

VACUUM PUMP OIL CHANGE OIL

From MAINTENANCE, select VACUUM PUMP OIL CHANGE, the following screen will be displayed

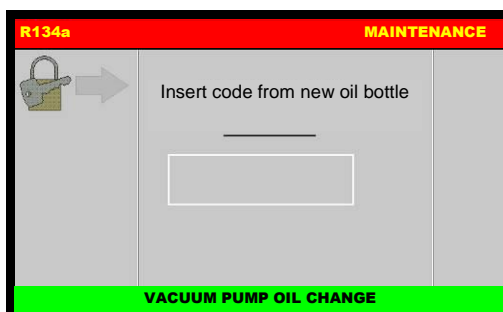

Enter the code (retrieved on the new oil bottle) and press OK to delete the alarm. If the code is not available, call the Service Center.

VACUUM PUMP

Perform the operations listed below on a routine basis in order to ensure good operation of the vacuum pump:

M1) Oil top-up.

M2) Oil change.

When topping-up or replacing the pump oil, use only the oil recommended by the manufacturer. Contact your retailer for information concerning the correct type of oil.

M.1) OIL TOP-UP

This operation must be performed when the level of the oil falls to less than half on the indicator (ref.3, Fig.20).

NOTE: in order to correctly check the oil level, run the pump for at least 1 minute (running a vacuum procedure in the hose for 1 minute) so that the oil fluidifies.

Check the oil level when the pump stops.

To refill the oil, perform the steps listed below in the order given.

Disconnect the *machine* from the mains supply.

Locate the filling cap (ref 1, Fig.20) and screw it completely off.

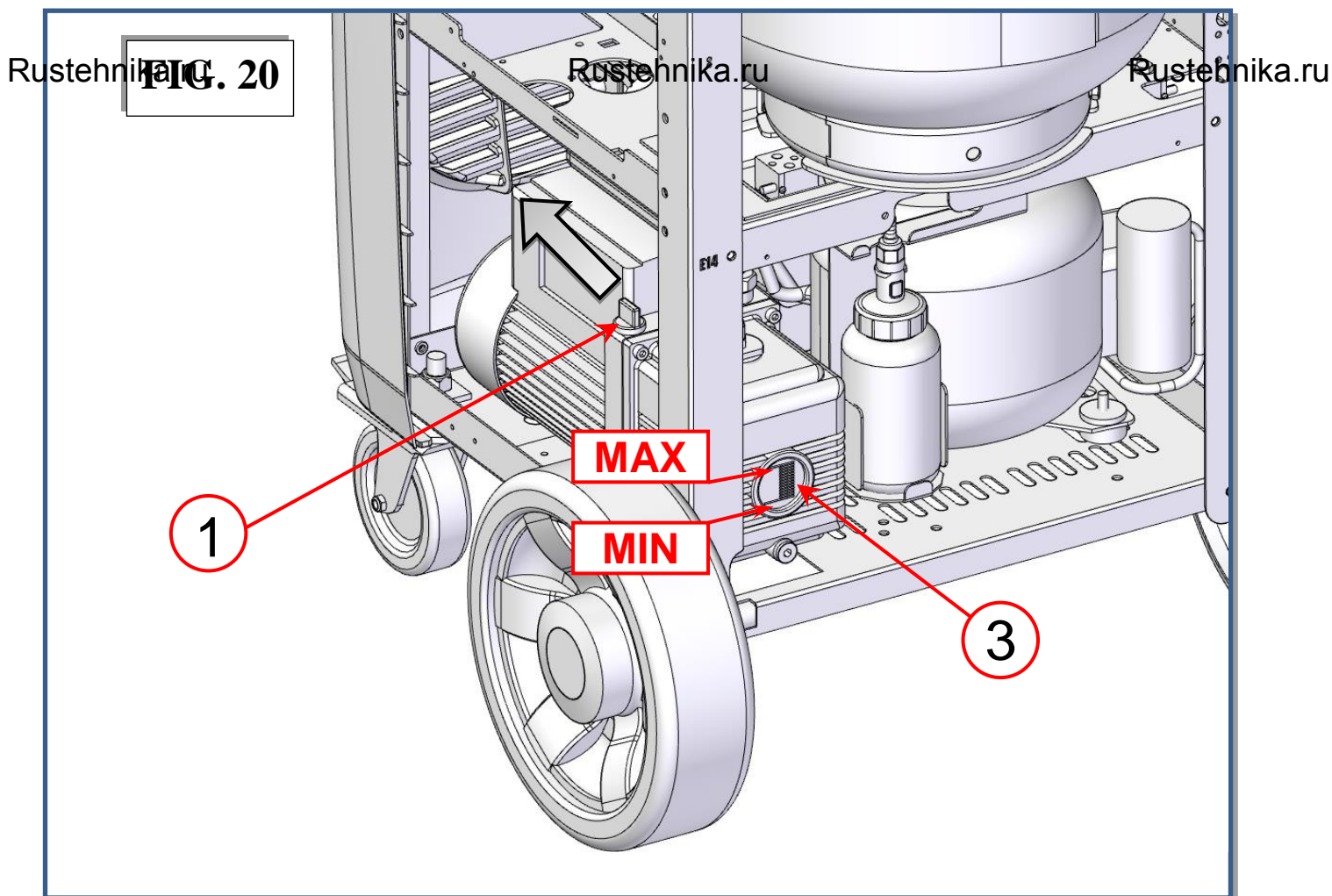

The oil must be added through the hole in which the oil cap was lodged by using a proper funnel (ref 5, Fig.21).

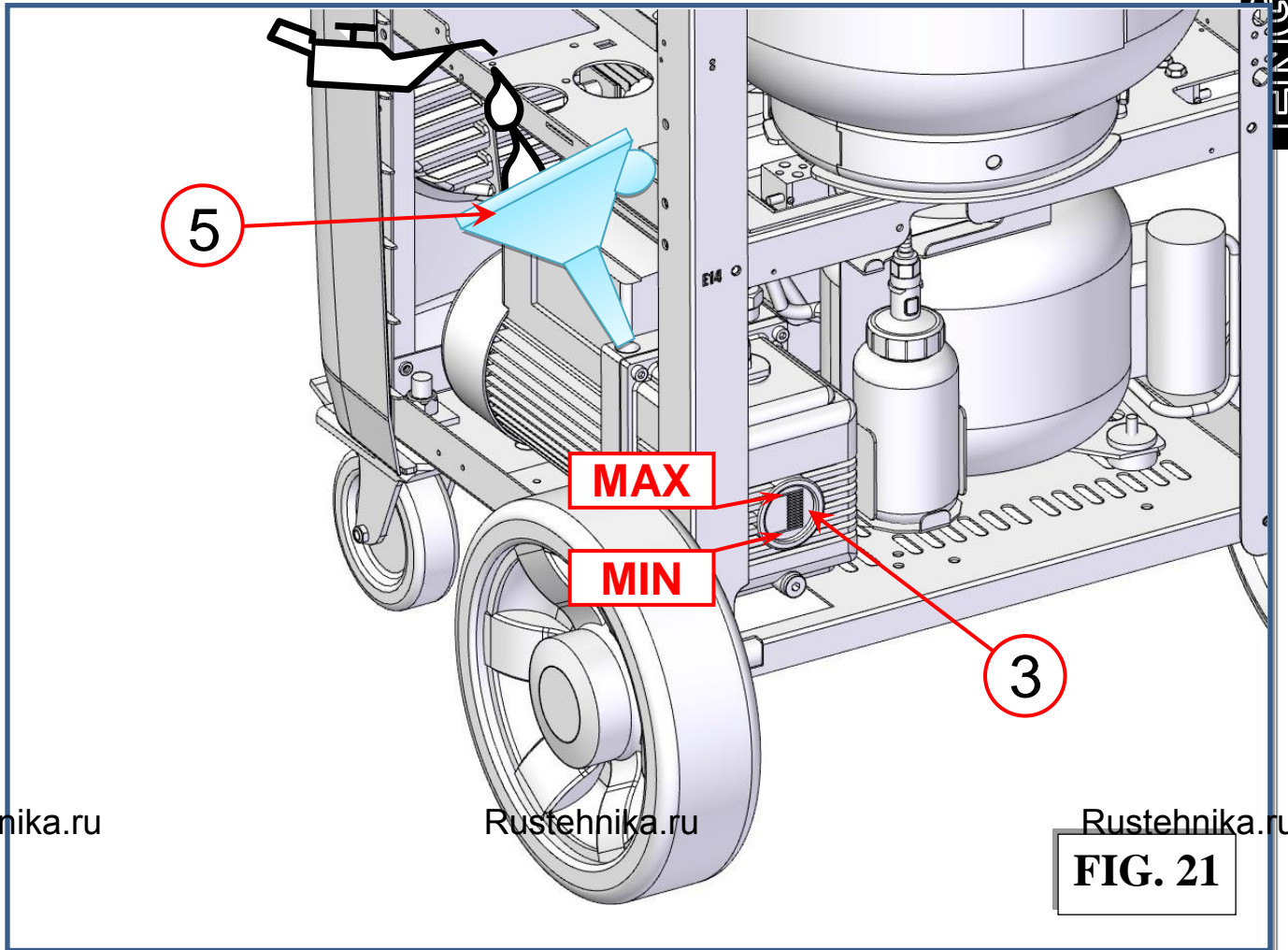

Add oil a little at a time, waiting for the level to rise before each successive addition, until the oil level is about $\frac{1}{2}$ cm above the red mark on the indicator (ref 3, Fig.21).

Replace the filling cap (ref 1, Fig.22) and tighten down.

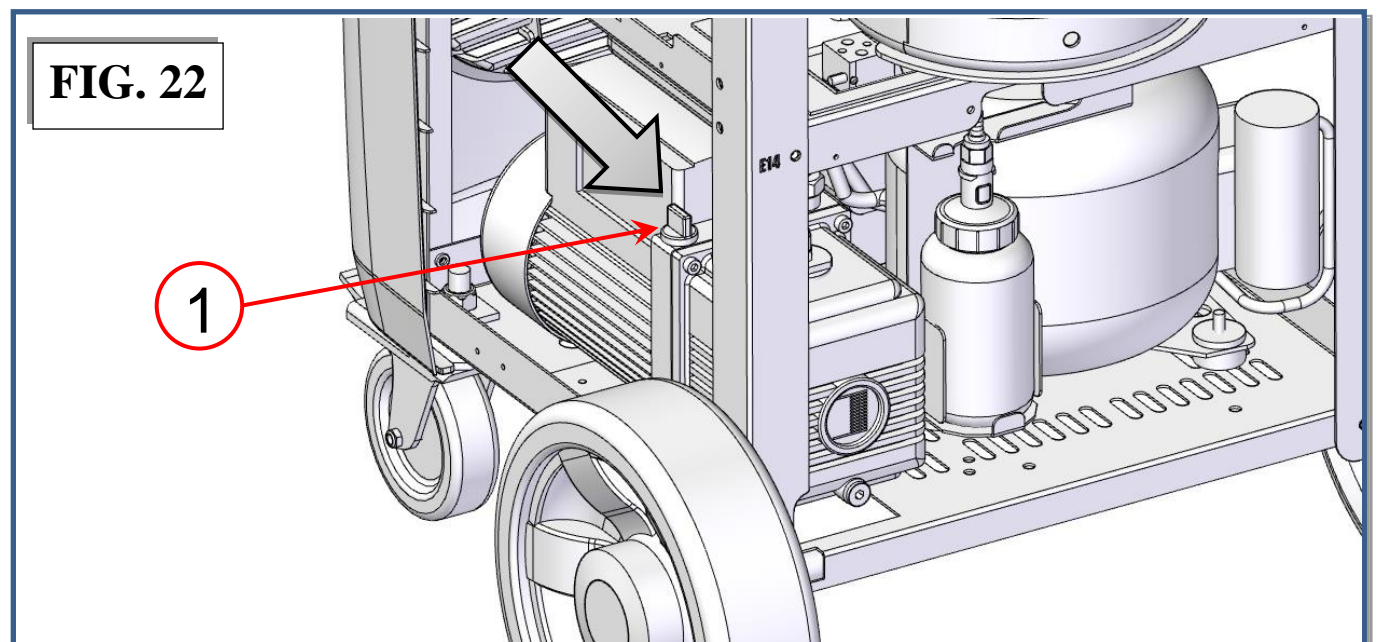

M.2) OIL CHANGE

The vacuum pump oil must be replaced every 20 hours of functioning and in any case every time the refrigerant filters are replaced.

NOTE: alarm message is visualized, to remove alarm message refer to VACUUM PUMP OIL CHANGE paragraph.

The oil must also be replaced whenever it changes color due to absorption of humidity. Before beginning the oil change procedure, procure a container of at least 500 cc capacity in which to collect the used oil. The pump contains about **250 cc of oil**. Use only the oils recommended by the manufacturer (consult your retailer); the use of a non-recommended oil may impair the proper functioning of the pump and void the warranty.

- 1) Disconnect the machine from the mains supply.
- 2) Place a container (ref 4 Fig.23). under the drain cap (ref 2, Fig.23).

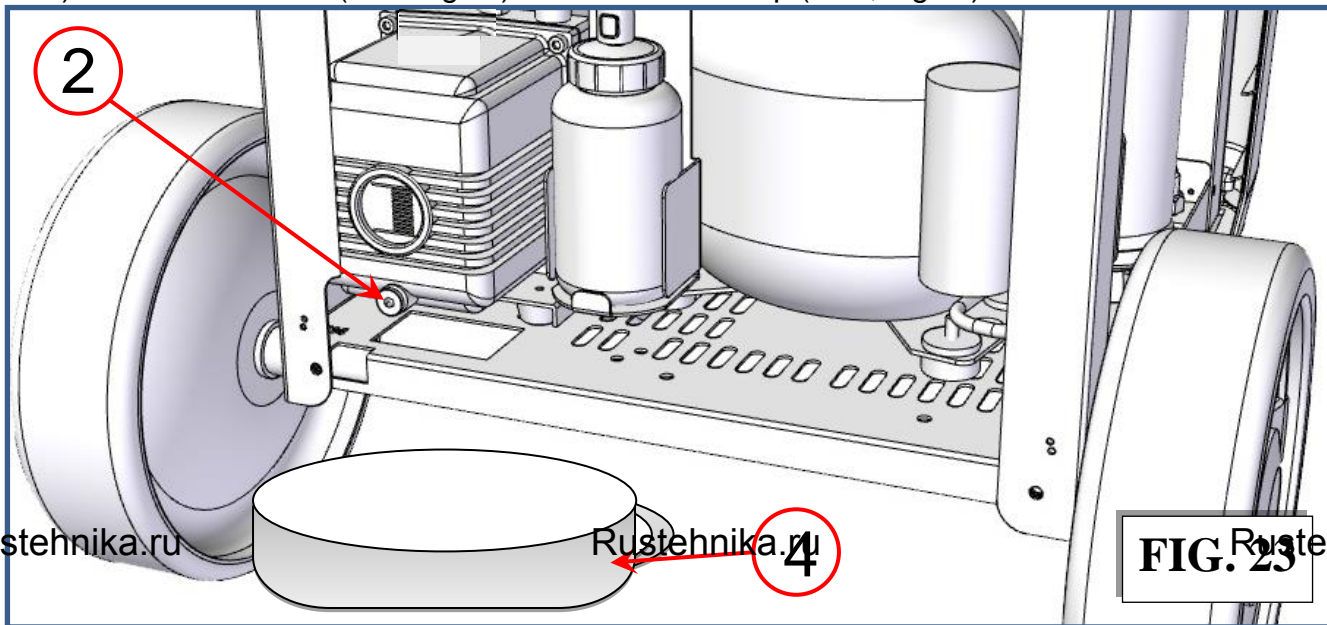

- 3) Unscrew the filling cap (ref 1, Fig.24).

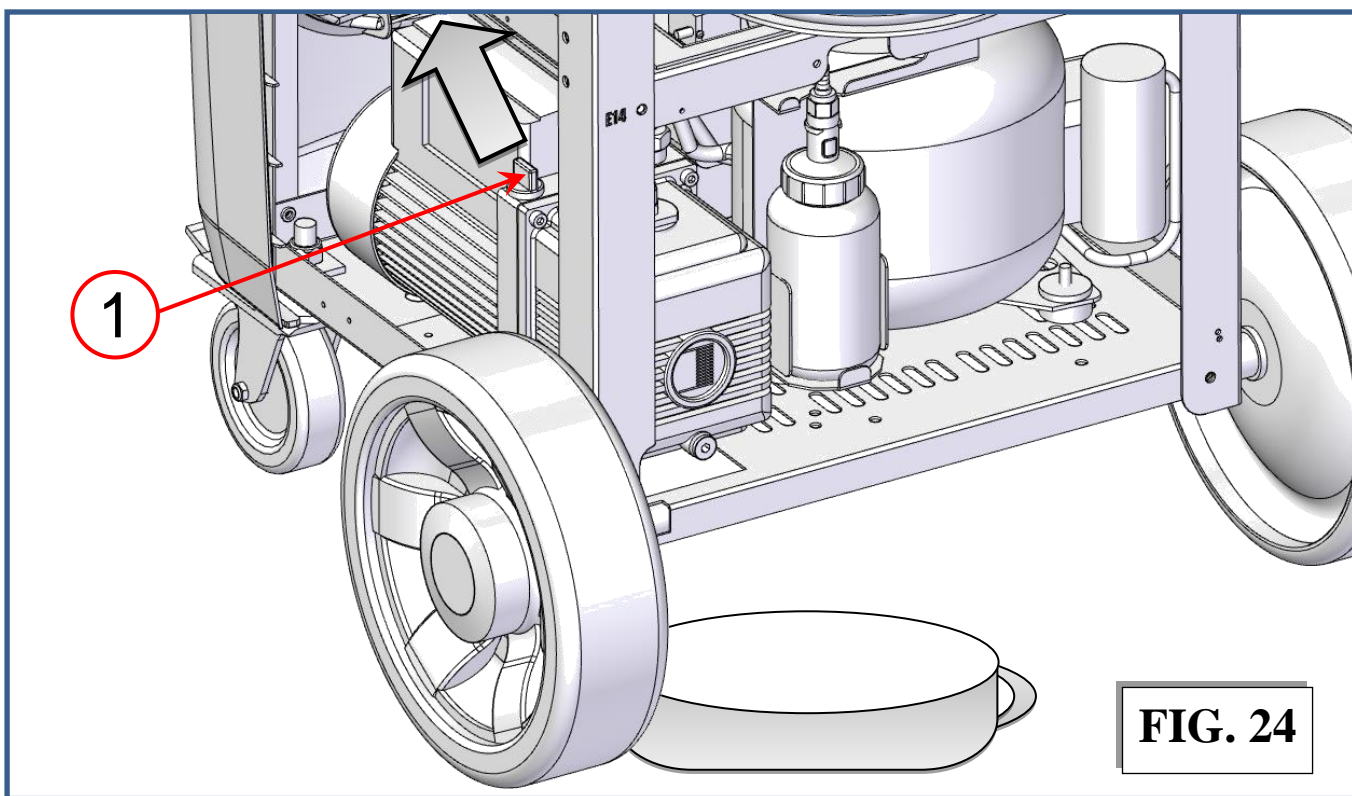

4) Unscrew the drain cap (ref 2, Fig.25).

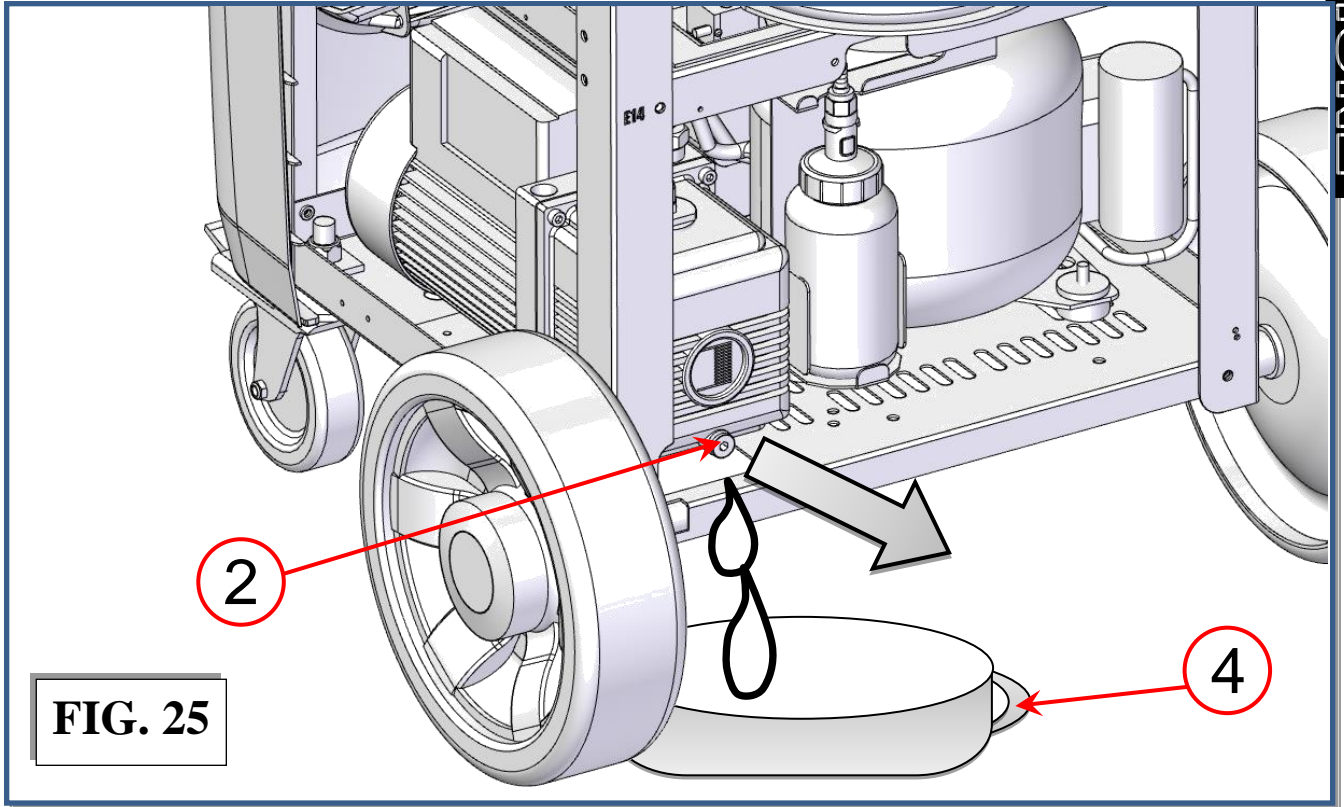

Allow all the oil to run out into a disposal container (ref 4 Fig.25) (with height < 10 cm).

5) Close the drain cap (ref 2, Fig.26).

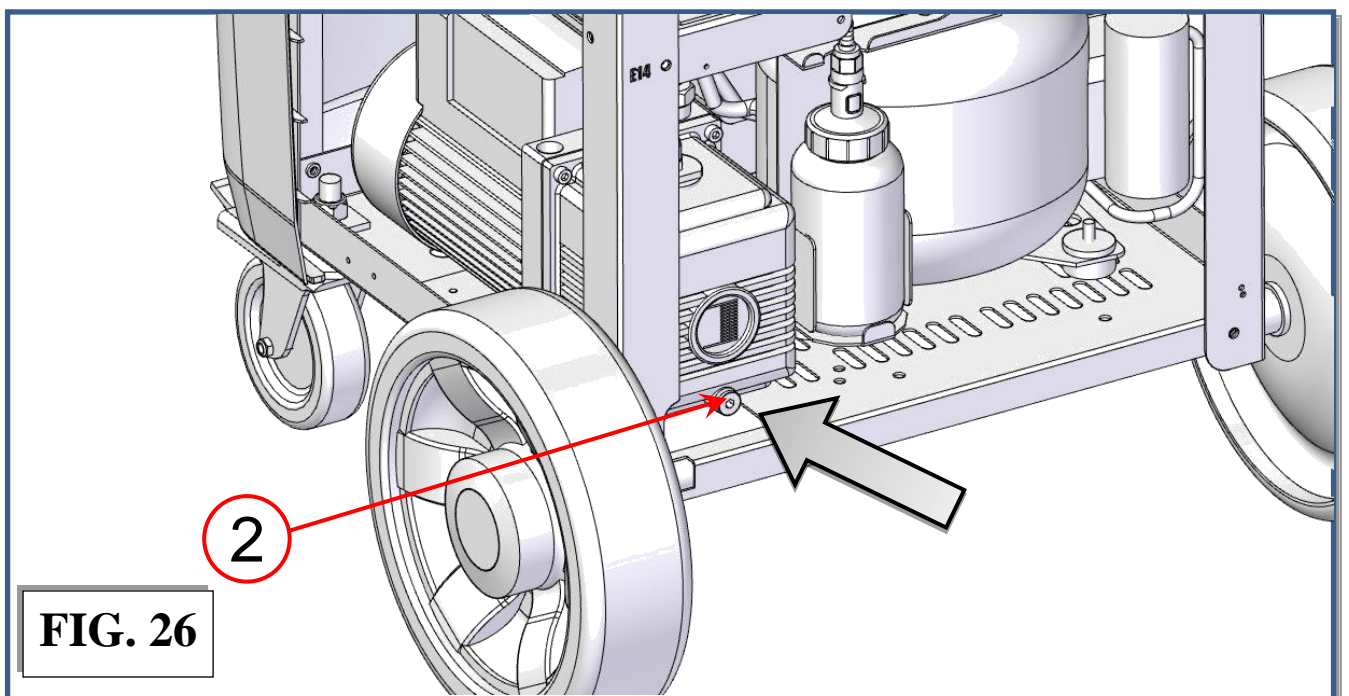

- 6) Pour in new oil through the filling hole, using a proper funnel (ref 5, Fig.27), until the level rises to the midpoint on the indicator (ref 3, Fig.27).

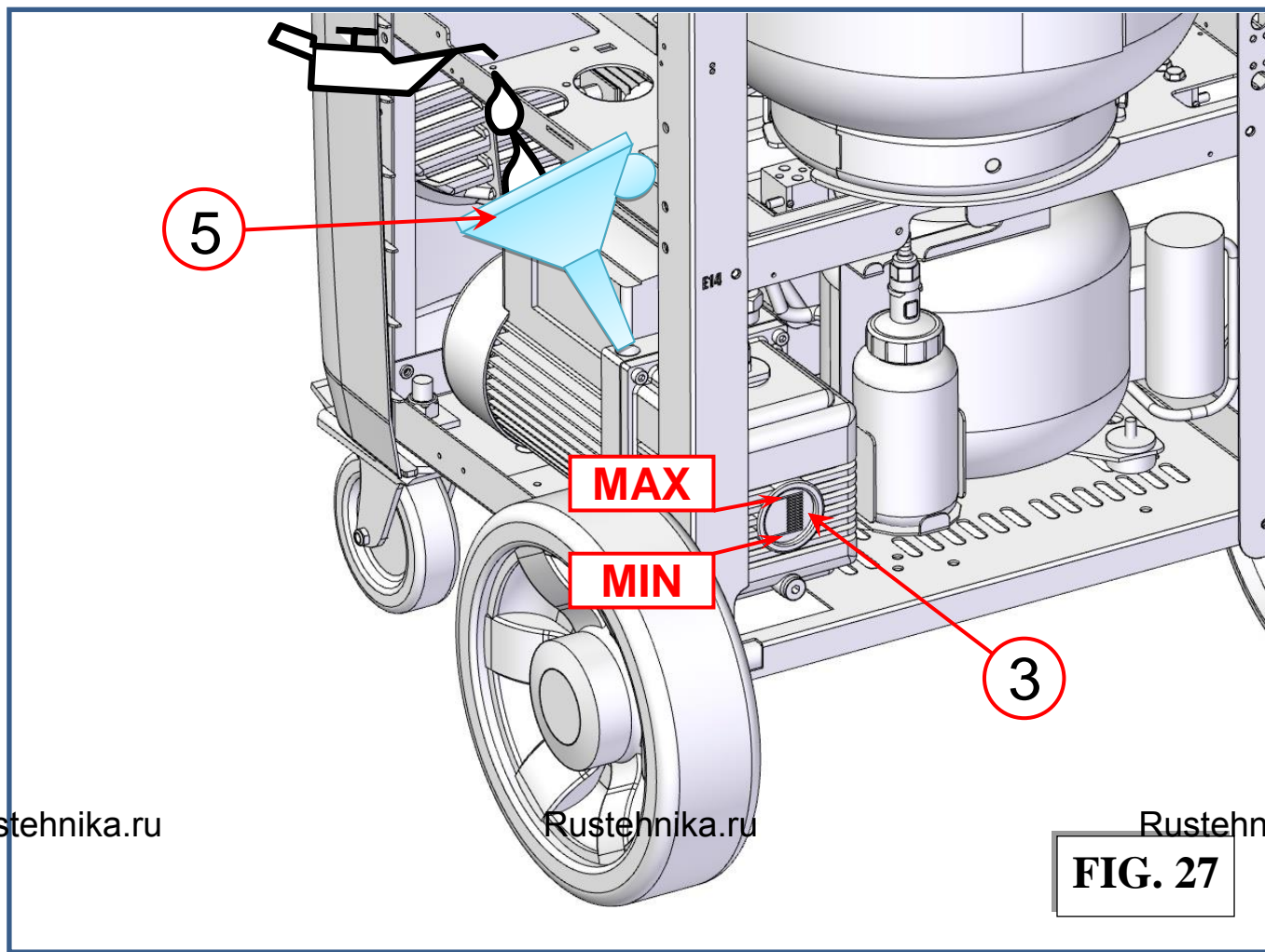

- 7) Replace the filling cap (ref 1, Fig.28) and tighten down.

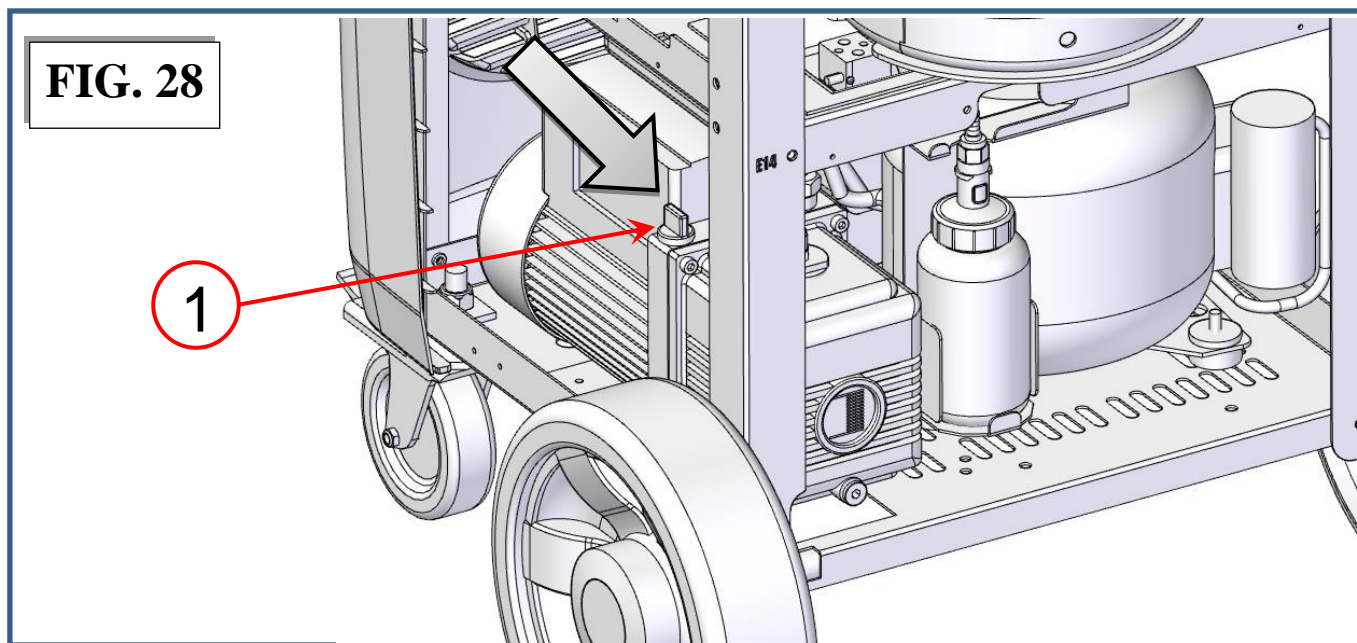

FILLING THE RECHARGEABLE COLLAPSIBLE NEW OIL CONTAINER

Types of oil: use only oils recommended by the manufacturer or by the car manufacturers. Always refer to the information provided by the A/C system manufacturer. Never use waste oil.

Procedure:

1. Press quick connection button (ref 1, Fig.29) to disconnect the oil container OIL container (ref j, Fig.29);
2. Remove the container from its lodging

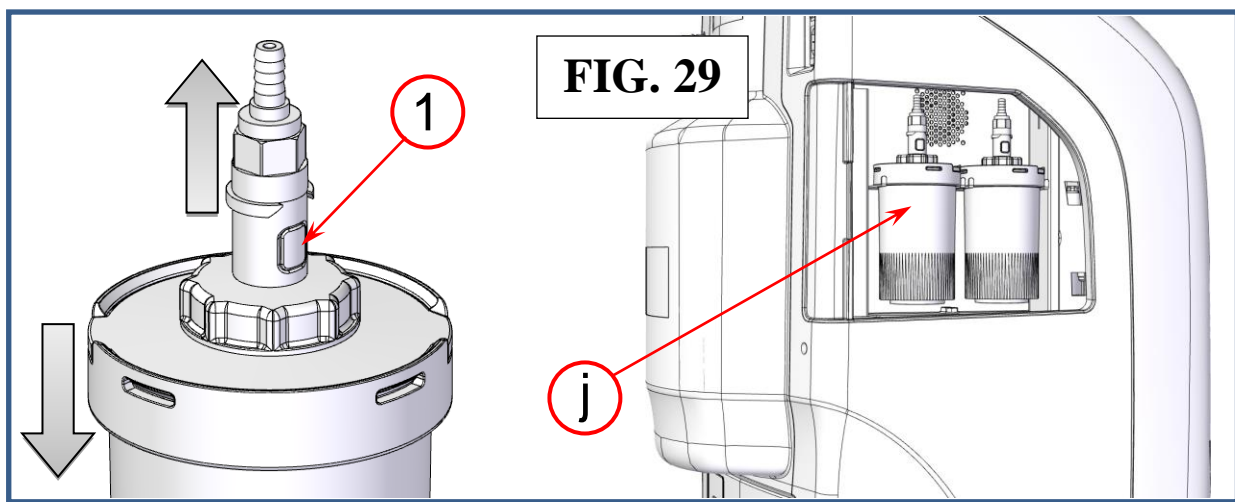

3. Hold the container and unscrew the cap (ref 2, Fig.30). Fill the container (Fig 31) with the correct quantity (about 250-260ml) of oil for compressors, of suitable type and grade.

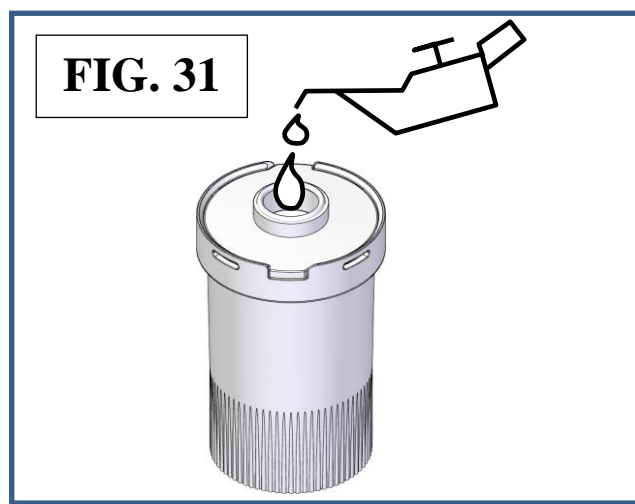
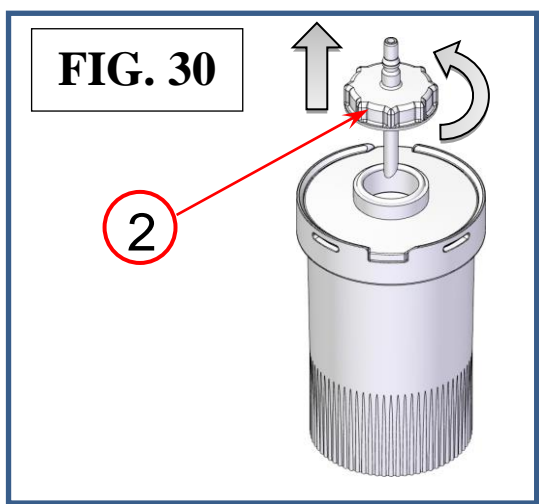

NOTE: in order to reduce humidity and air contamination of new oil, the collapsible container has to be filled almost to the brim.

4. Screw the cap (ref 2, Fig.30) back into the container.
5. Replace the container and hook it up to the quick connection taking care not to exert pressure on the scale in order not to damage it.

FILLING THE RECHARGEABLE COLLAPSIBLE UV CONTAINER

N.B.: Using UV not recommended by the manufacturer will invalidate the warranty.

Procedure:

1. Press quick connection button (ref 1, Fig.32) to disconnect the UV container.
2. Lift the UV container out of its lodging (ref I, Fig.32),

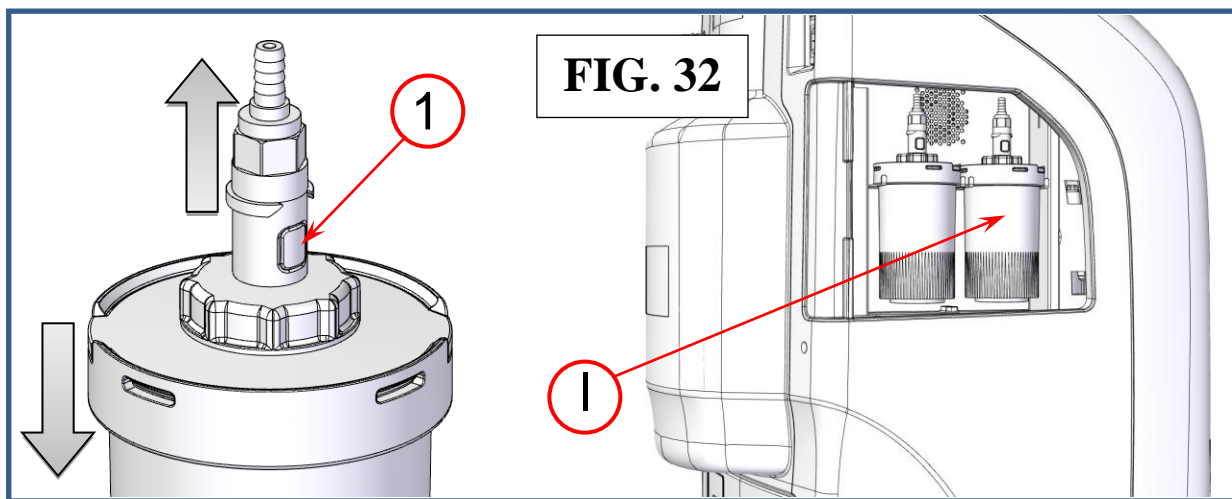

3. Unscrew the cap (ref 2, Fig.33) and fill the container (Fig.34) with the required quantity of UV for compressors.

Rustehnika.ru

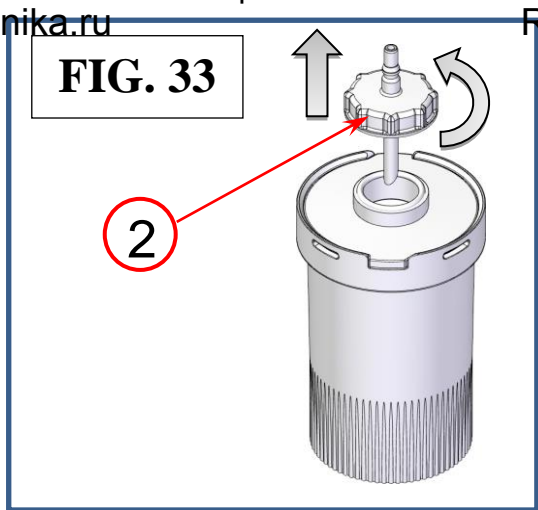

Rustehnika.ru

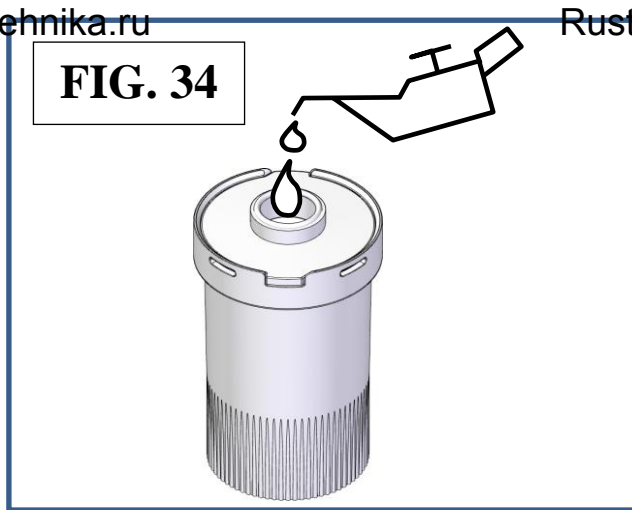

Rustehnika.ru

4. Screw the cap (ref 2, Fig.33) back into the container.
5. Replace the container and hook it up to the quick connection taking care not to exert pressure on the scale in order not to damage it.

NOTE: in order to reduce humidity and air contamination of UV, the collapsible container has to be filled almost to the brim.

REPLACE THE NEW OIL CARTRIDGE

When the level of the new oil drops by a few ml it is best to replace the collapsible cartridge in order to have a sufficient reserve.

Types of oil: use only oil cartridges recommended by the manufacturer. Always refer to the information provided by the A/C system manufacturer.

Procedure:

1. Press quick connection button (ref 1, Fig.35) to disconnect the oil cartridge OIL cartridge (ref j, Fig.35);
2. Remove the used cartridge container from its lodging

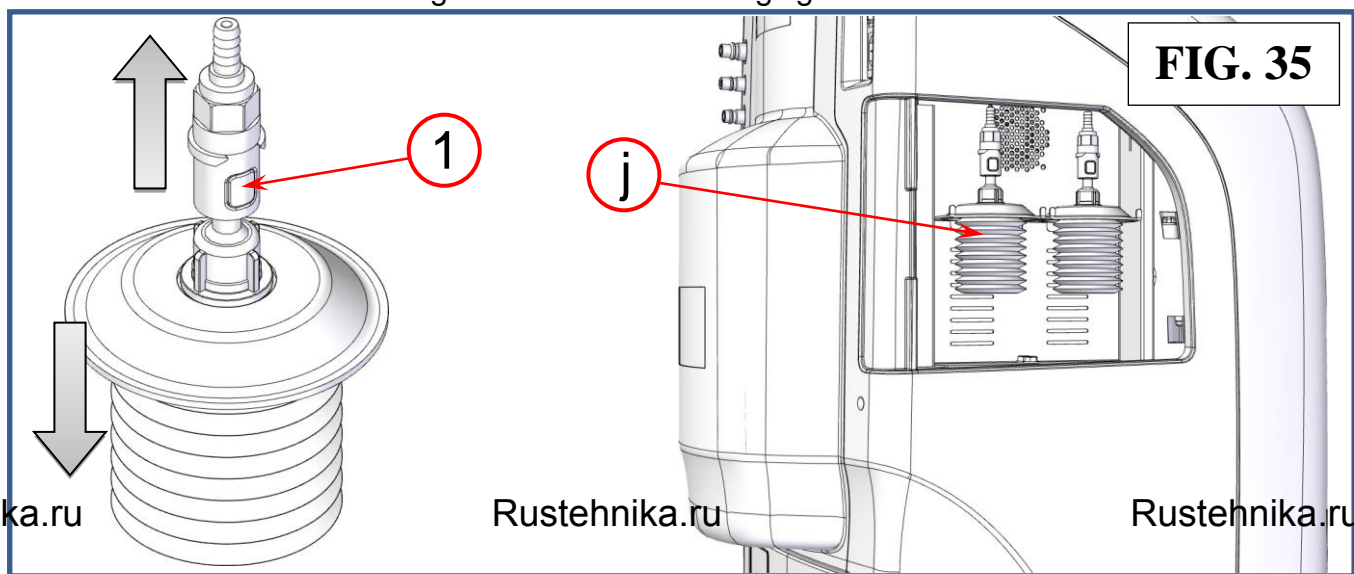

3. insert the male fitting of new oil cartridge into the quick connection and replace the cartridge in its lodging.

NOTE: Replace the cartridge taking care not to exert pressure on the scale in order not to damage it.

REPLACE THE NEW UV CARTRIDGE

N.B.: Using UV not recommended by the manufacturer could damage the electronic valves and will invalidate the warranty.

Procedure:

1. Press quick connection button (ref 1, Fig.36) to disconnect the UV cartridge.
2. Lift the UV cartridge out of its lodging (ref I, Fig.36),

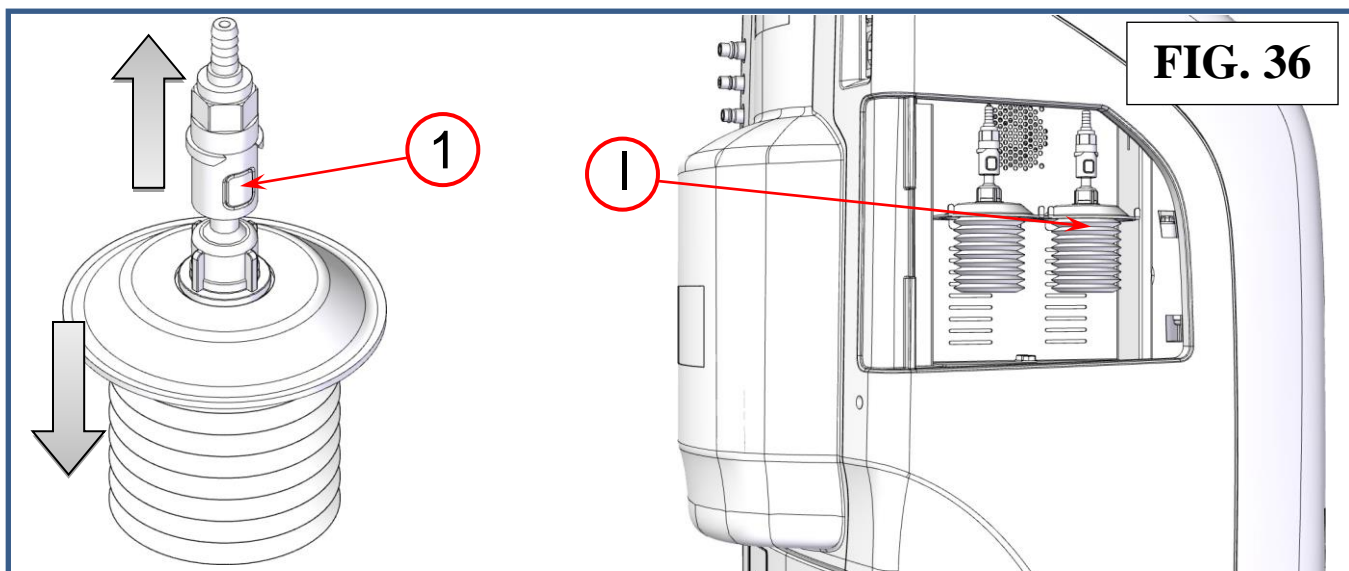

Rustehnika.ru

Rustehnika.ru

Rustehnika.ru

3. Insert the male fitting of the new UV cartridge into the quick connection and replace the cartridge in its lodging.

NOTE: Replace the cartridge taking care not to exert pressure on the scale in order not to damage it.

EMPTYING THE USED OIL CONTAINER

Procedure:

1. Press quick connection button (ref 1, Fig.37) to disconnect the used oil container
2. Lift the used oil container out of its lodging (ref n, Fig.37) without exerting pressure on the scale.

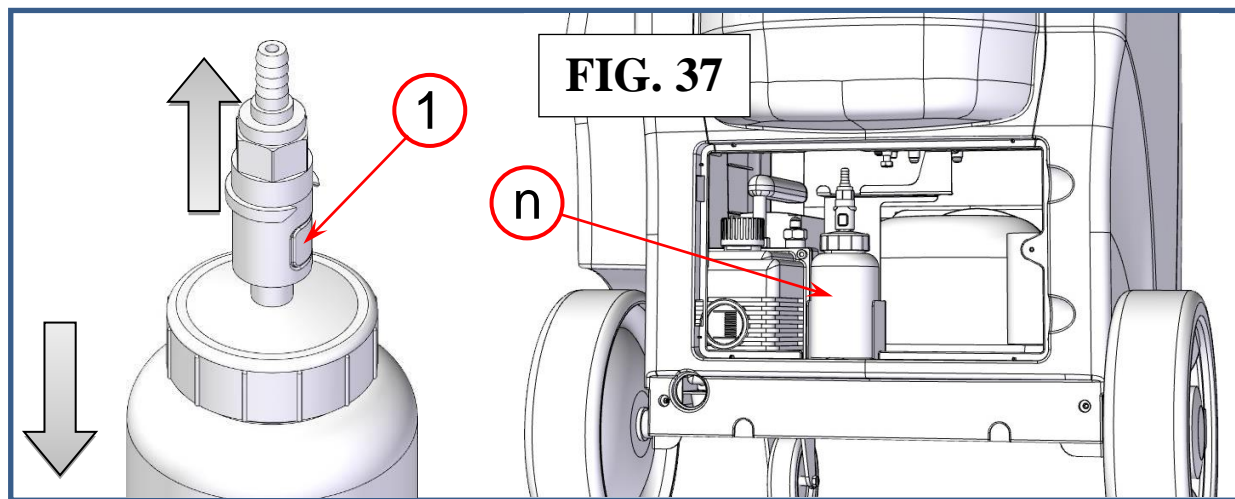

3. Unscrew the cap (ref 2, Fig.38) while holding the container; empty the used oil into a suitable container for used oils (Fig.39).

Rustehnika.ru

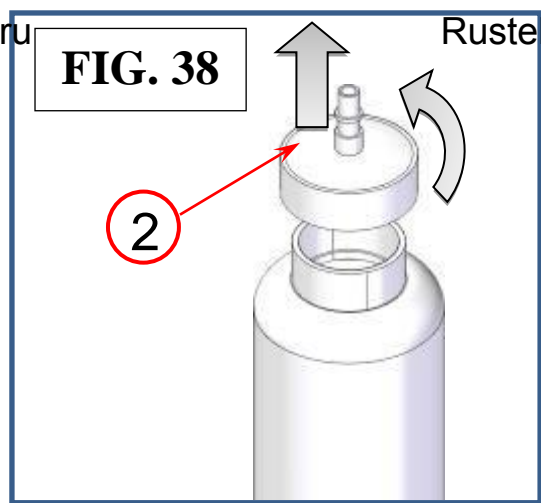

Rustehnika.ru

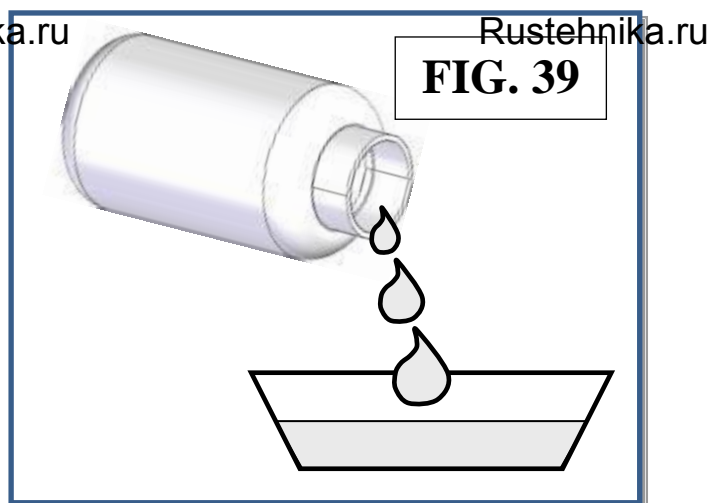

Rustehnika.ru

4. Screw the cap back into the container.
5. Replace the container and hook it up to the quick connection taking care not to exert pressure on the scale in order not to damage it.

NOTE: In order to avoid damage to the oil scale, never exert pressure on it either from above or from below.

REPLACING THE PRINTER PAPER

Open the print cover (ref 3, Fig.40), and replace the paper roll with a new one

Use only heat-sensitive paper of the type described below.

Paper width: 58 mm

Maximum paper roll diameter: 40mm

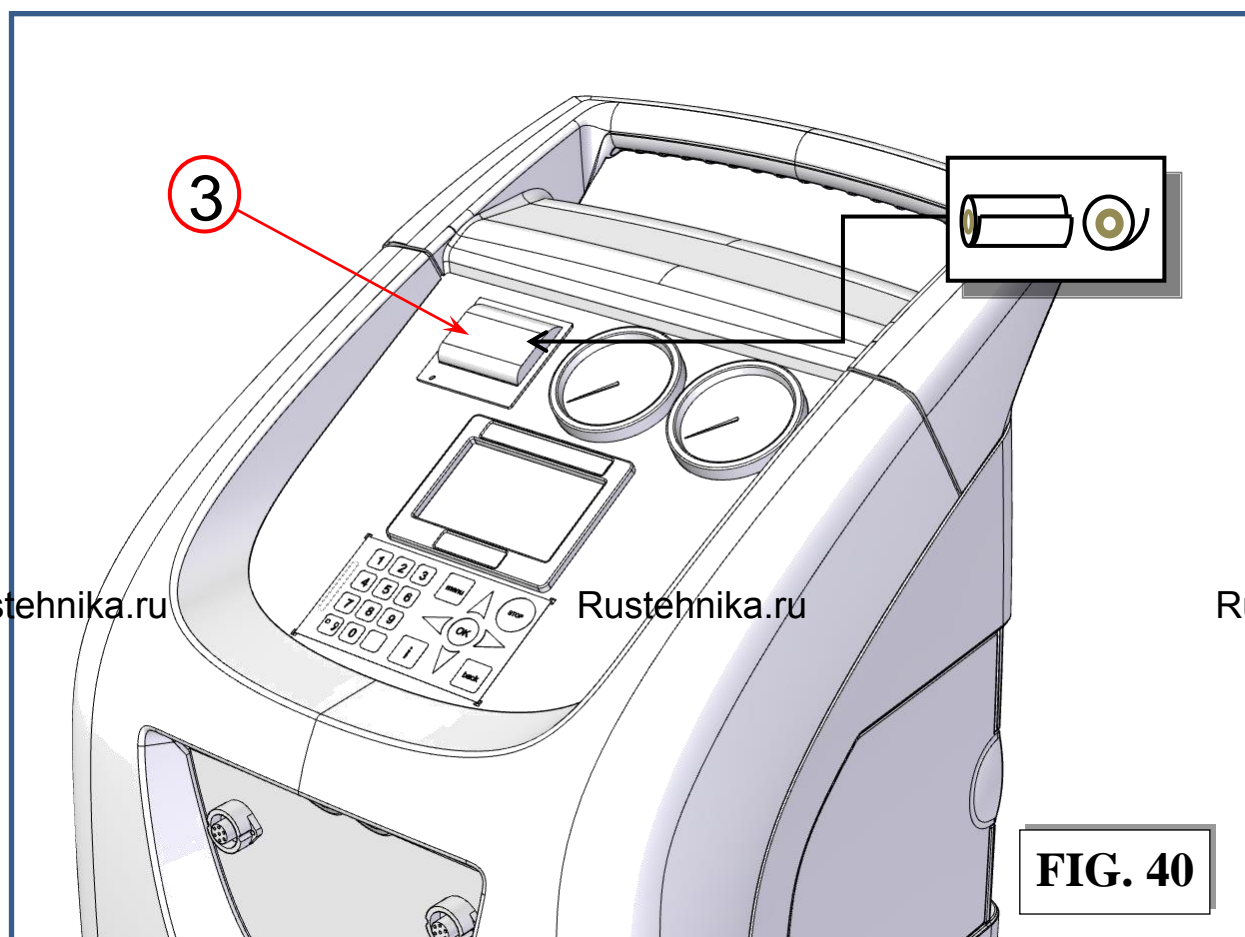

DATA

From the MAIN MENU:



Select the DATA (or press “i” key of the keypad), the following screen will be displayed:

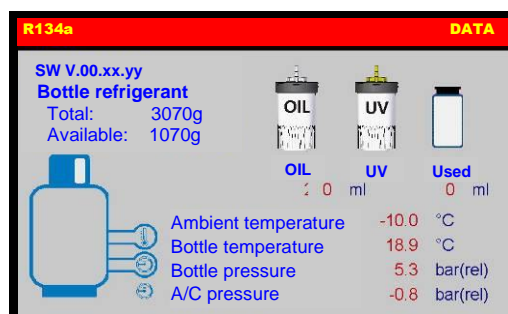

- SW V.: Software version
- Bottle refrigerant:
 - Total: total amount of refrigerant in the storage bottle
 - Available: quantity of refrigerant available in the storage bottle.
- OIL/UV: sum of the quantity of OIL and DYE in the OIL and DYE containers
- Used: quantity of OIL in the USED OIL container.
- Ambient temperature: ambient temperature near the service station
- Bottle temperature: refrigerant storage bottle temperature
- Bottle pressure: refrigerant storage bottle pressure.
- A/C pressure: pressure in the service hoses.

Press OK to return to MAIN MENU.