







GTX 186/B - GTX 186/C

3,0 t





CE

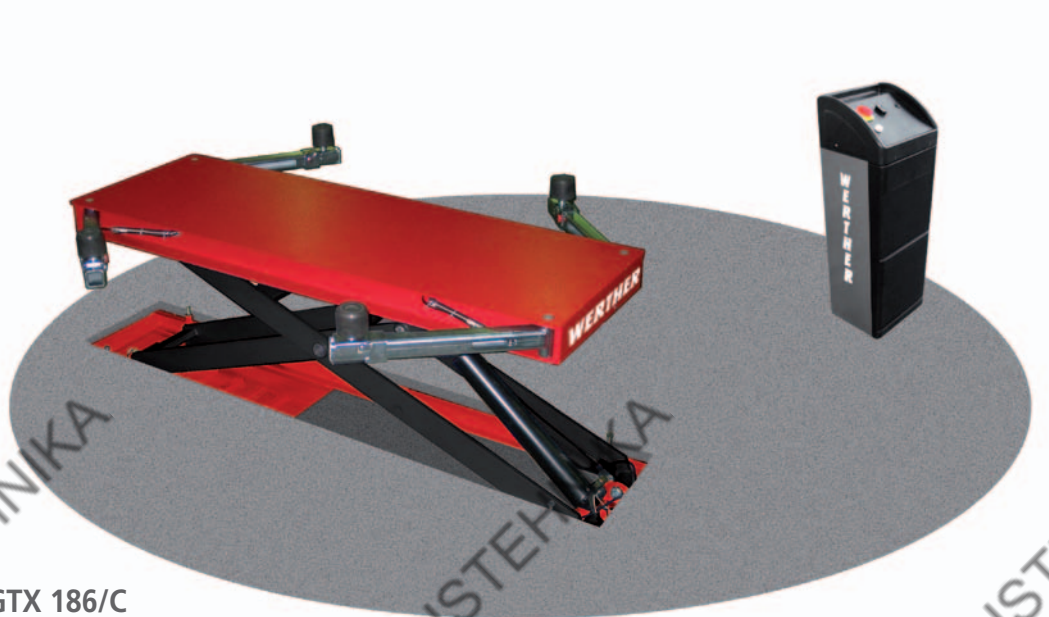

-  Sollevatore elettroidraulico a forbice per carrozzerie
-  Electro-hydraulic scissor lift for car body shops
-  Elektrohydraulischer Scherehnheber für Karosseriewerkstätten
-  Élévateur électrohydraulique ciseaux pour carrossiers
-  Elevador electro-hidráulico de tijera para carrocerías



GTX 186/C

-  Comandi uomo presente, 24V • Sicurezze elettriche • Sicurezze idrauliche e meccaniche ad azionamento pneumatico • Adatto per essere installato a scomparsa nei forni per carrozzeria e grigliati e nelle zone di preparazione • Completo di tubazioni idrauliche premontate per installazione centralina a max 5mt. • Regolazione altezza di chiusura da terra per adattamento alle profondità dei grigliati • Fornito con 4 tamponi in gomma h = 40 mm. • Segnale acustico ultimo tratto di discesa
-  "Dead man" controls, 24V • Electrical safety devices • Hydraulic and mechanical safety devices with pneumatic release • Suitable for recessed installation in bodyshop spraybooths, grids and preparing areas • Complete with pre-mounted hydraulic pipes enabling the installation of the control unit at max 5mt. • Closing height from the ground can be adjusted according to the deepness of the grid • Equipped with 4 rubber pads, h = 40mm • 'Buzzer' on last portion of descent
-  24 V-Totmannschaltung • Elektrische Sicherheitsvorrichtungen • Hydraulische Sicherheitsvorrichtungen und mechanische, pneumatisch entriegelbare Klinken • Geeignet als Einbaubühne in Betonwanne, bündig mit Bodengitter oder im Fahrzeug-Vorbereitungsbereich • Komplett vormontiertes Rohrsystem. Steuerpult kann bis in 5 m Entfernung aufgestellt werden • Einstellmöglichkeit der Mindesthöhe, als Anpassung an die Höhe der Bodengitter • 4 Gummi- Fahrzeugaufnahmeblöcke, h = 40 mm • Akustisches Signal im letzten Teil der Senkbewegung
-  Commande «homme mort», 24V • Sécurité électriques • Sécurité hydrauliques et crochets mécaniques à déclenchement pneumatique • Indiqué pour installation encastré au sol dans les cabines de peinture ou encastré dans les grilles dans les zones de préparation véhicules • Livré complet avec toute la tuyauterie hydraulique préinstallée, apte à l'installation du pupitre jusqu'à une distance de 5 m • Réglage de la hauteur min. pour l'adaptation aux grilles • Livré avec 4 tampons en caoutchouc, h = 40 mm • Signal sonore sur la dernière partie de descente
-  Mandos de hombre presente, 24V • Seguridad eléctricas • Seguridad hidráulicas y mecánicas con activación neumática • Idóneo para instalaciones empotradas en el piso de hornos para carrocería y emparrillados en las áreas de preparación • Completo de tuberías hidráulicas pre-montadas para instalación de centralita a máx. 5 m., • Regulación de la altura de cerrado para adaptación a las profundidades de los emparrillados • Suministrado con 4 tacos de goma h=40mm • Señal acústica último tramo de descenso

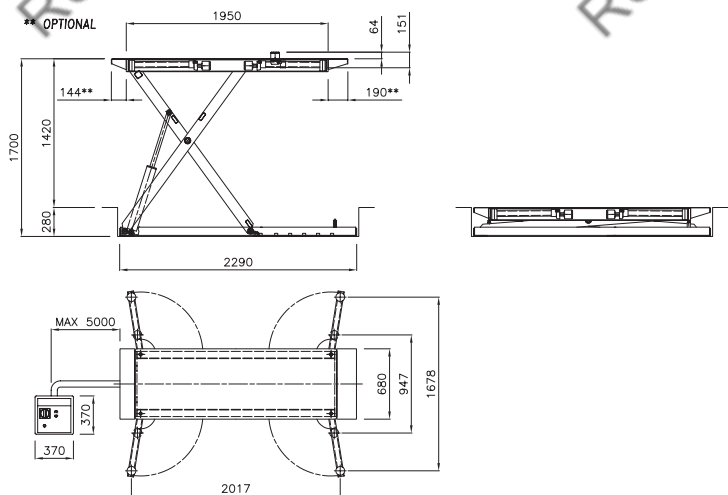

Per la realizzazione di opere civili chiedere disegni di dettaglio.

Please ask for detailed drawings to create basement foundations.

Para la realización de obras civiles preguntar dibujo tecnico con detalle.

Dati tecnici	Technical data	Technische Eigenschaften	Caractéristiques techniques	Datos técnicos
Funzionamento • Operation • Funktionsweise • Fonctionnement • Funcionamiento		Elettroidraulico • Electro-hydraulic • Elektrohydraulisch • Électrohydraulique • Electro-hidráulico		
Portata • Capacity • Tragfähigkeit • Capacité • Capacidad		3.000 kg		
Peso • Weight • Gewicht • Poids • Peso		650 kg		
Salita/Discesa • Lifting/lowering • Hub/Senkzeit • Temps de levage/descente • Subida/bajada		40/50 s		
Altezza di sollev.* • Lifting height* • Hubhöhe* • Hauteur de levage* • Altura de elevación*		1700 mm		
Motore • Motor • Motorleistung • Puissance moteur • Motor		1,75 kW - 230-400V/50 Hz 3 ph		

*: dal pavimento / from floor / ab Boden / du sol / desde el suelo

Studiato per essere installato nei forni per carrozzeria
Installazione standard in grigliato

Designed to be installed in body shop spraybooths
Standard installation into grating

Besonders geeignet für den Einbau in Spritzkabinen
Standardinstallation in Gitterrost

Conçu pour l'installation dans les cabines de peinture
L'installation standard est en grille

Proyectado para ser instalado en los hornos para carrocería
Instalación estándar en emparrillado

GTx 186/B



Versione con braccetti orientabili manualmente
Version with manually adjustable arms
Version mit handschwenkbaren Armen
Version avec bras réglables manuellement
Versión con brazos orientables a mano

GTx 186/C



Versione con braccetti orientabili pneumaticamente
Version with pneumatically adjustable arms
Version mit pneumatisch schwenkbaren Armen
Version avec bras réglables pneumatiquement
Versión con brazos orientables neumáticamente

Opzioni	Optionals	Sonderzubehör	Options	Opcionales
Prolunghe per tubi idraulici 2 m Pulsantiera di comando remoto via cavo Accessori per installazione a incasso in pavimento Esecuzione con motore monofase Versioni conformi a normativa ATEX cl.2 (GTx 186/B, GTx 186/C)	Hose extensions 2 m Cable connected remote control Accessories needed for inground installation Single-phase motor Versions according to ATEX cl.2 standards (GTx 186/B, GTx 186/C)	Rallonges pour tuyaux hydrauliques 2 m Kabel-Fernsteuerung Zubehör für bodenebenen Einbau (in Grube) Ausführung mit Einphasenmotor Ausführung gem. ATEX-cl.2-Norm (GTx 186/B, GTx 186/C)	Schlauchverlängerungen 2 m Commande supplémentaire portable avec câble Accessoires nécessaires pour installation encastrée en sol Moteur monophasé Versions conformes à la norme ATEX cl.2 (GTx 186/B, GTx 186/C)	Prolongaciones para tubos hidráulicos 2 m Botonera de mandos remota por cable Accesorios para instalación empotrada en el suelo Motor monofásico Versiones conformes con la norma ATEX cl.2 (GTx 186/B, GTx 186/C)

The company reserves the right to introduce improvements in design or specification without prior notice