







# Ravaglioli

COMPANY WITH  
QUALITY SYSTEM  
CERTIFIED BY DNV GL  
= ISO 9001 =

- DUE COLONNE ELETTROIDRAULICI 
- ELECTRO-HYDRAULIC 2 POST LIFTS 
- ELEKTROHYDRAULISCHE 2-SÄULEN HEBEBÜHNEN 
- 2 COLONNES ELECTRO-HYDRAULIQUES 
- DOS COLUMNAS ELECTRO-HYDRAULICOS 

## KPH

370.32

370.42

370.45EX

370.50

rustehnika.ru

rustehnika.ru

rustehnika.ru

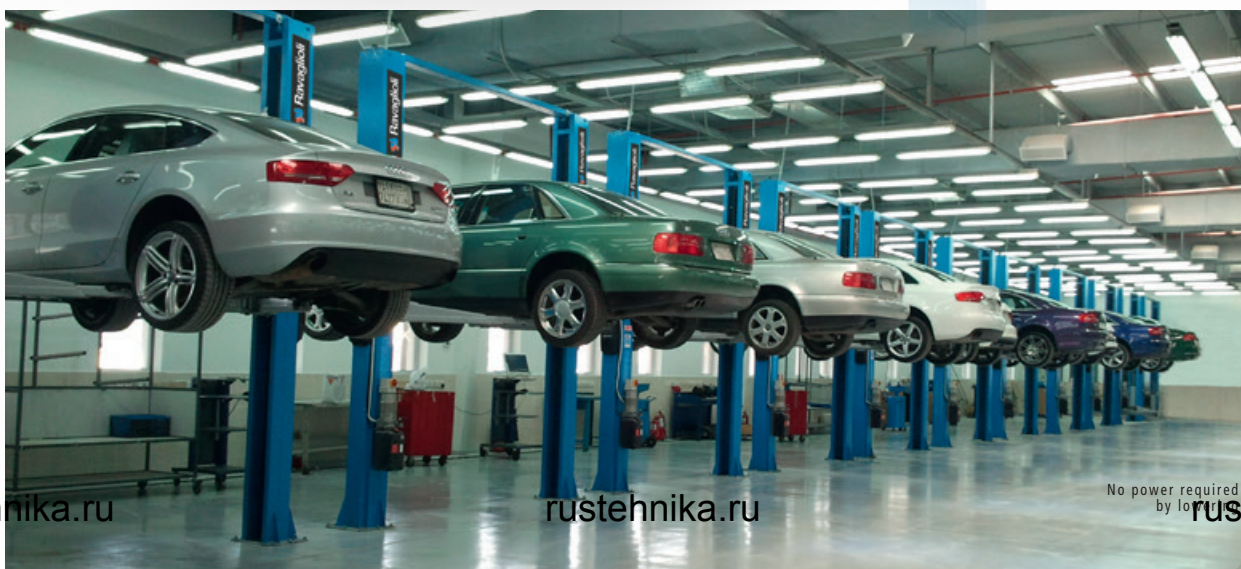

rustehnika.ru

rustehnika.ru

No power required  
by low voltage 



### KPH370.32K / 3200 kg

Bracci corti a tre stadi per il sollevamento asimmetrico agevole anche di veicoli larghi.

Altezza minima tamponi di soli 90 mm.

Bracci predisposti per l'alloggiamento rapido di prolunghe e accessori di sollevamento.

*Three - stage short arms for asymmetric lifting of large vehicles. Min. pad height 90 mm.*

*Arms suitable for quick drop-in extensions and other lifting accessories.*

Kurze Arme zweimal ausziehbar um leichter auch breite Fahrzeuge asymmetrisch hochzuheben. Unterschwenkhöhe nur 90 mm.

Aufnahmen mit Schnellstecksystem erleichtern den Einsatz von Verlängerungen und anderem Zubehör.

*Bras courts à 3 étages, pour faciliter le chargement asymétrique des véhicules larges. Hauteur des tampons 90 mm.*

*Bras prédisposés pour le montage rapide des rallonges et d'autres accessoires de levage.*

Brazos cortos de triple extensión, para el levantamiento de vehiculos anchos también. Altura mínima de los tacos del suelo solamente 90 mm.

Brazos predispuostos para el alojamiento rapido de suplementos para los tacos y accesorios.



rustehnika.ru

rustehnika.ru

rustehnika.ru

#### OPTION

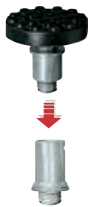

#### SPECIAL VERSIONS

	H1	H2
VAR3725	1870	3725 (3625)
VAR3975	2005	3975 (3875)
STANDARD	2005	4165 (4065)
VAR5000	2005	5000 (4900)

Varianti per altezza massima.  
Different extensions in height.

### KPH370.32R / 3200 kg

Bracci super-ribassati, con profilo parallelo al pavimento. Tamponi a doppio filo con altezza minima di soli 75 mm.

*Extra low profile arms, parallel to the floor. Double thread pads with a min. height of 75 mm only.*

Sehr niedrige Arme, und zwar die ganze Länge entlang paralleles Profil zum Boden. Aufnahmen mit Stecksystem und 75 mm Unterschwenkhöhe.

*Bras extra plats, avec profil parallèle au sol.*

*Tampons à double rallonge avec hauteur mini. de 75 mm.*

Brazos extra bajos, con perfil paralelo al suelo. Tacos de doble extensión con altura mínima de 75 mm.



rustehnika.ru

rustehnika.ru

rustehnika.ru

#### KPH370.32K, KPH370.32R

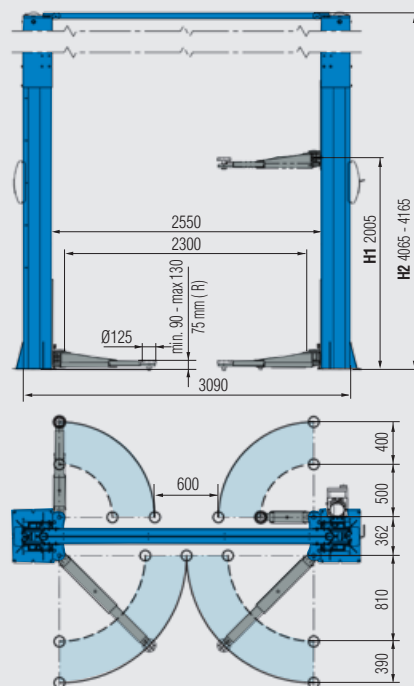

## SAFETY

Dispositivo di appoggio meccanico ad inserimento automatico a garanzia della massima sicurezza in fase di stazionamento.

*Mechanical safety latch with automatic engagement ensuring maximum safety when lift is in standing position.*

Mechanische Stützvorrichtung mit automatischer Einschaltung um eine maximale Sicherheit im aufgehobenen Zustand zu garantieren.

*Dispositif de soutien mécanique avec enclenchement automatique pour garantir la sécurité totale pendant le stationnement.*

Dispositivo de apoyo mecánico de funcionamiento automático como garantía de la máxima seguridad en la fase de estacionamiento.



## AUTOMATIC

Arresto bracci a inserimento automatico e sgancio automatico a terra.

*Automatic arm locking during lifting and automatic unlocking when the arms reach the floor.*

Automatische Armarretierung.

*Blocage de bras automatique il est dégagé au sol.*

Bloqueo de brazos automatico y desenganche de brazos automatico al suelo.

## SYNCHRONIZATION

I cavi non portanti garantiscono la sincronizzazione.

*Synchronization cables grant the levelling of the two carriages.*

Gleichlauf mittels Seile (nicht tragend).

*La synchronisation est garantie grace à un cable d'acier non-portant.*

Los cables no portantes garantizan la sincronización.

## MAINTENANCE FREE

In ciascuna colonna è presente un pistone di sollevamento che non richiede alcuna manutenzione.

*Each column features a maintenance-free lifting cylinder.*

Wartungsfreie Zylinder in jeder Säule.

*Chaque colonne est équipée d'un vérin conçu pour un fonctionnement "sans entretien."*

En cada columna está presente un pistón de elevación que no requiere mantenimiento alguno.

## FLEXIBILITY

Altezza regolabile.

*Adjustable height.*

Justierbare Höhe.

*Hauteur réglable.*

Altura regulable.

## RAVAGLIOLI VS OTHER LIFTS

A veicolo sollevato, il pistone è esposto a possibili danni

*When vehicle is lifted, piston shaft is exposed to damage*

Im angehobenen Zustand ist die Kolbenstange schadensgefährdet

*Avec le véhicule levé, le vérin est exposé et risque des dommages*

Con el vehículo levantado, el pistón se expone a posibles daños



OTHER LIFTS



RAVAGLIOLI

Il pistone scompare a garanzia di lunga durata e bassi costi

*The piston is hidden for long life and low operation costs*

Der Zylinder ist geschützt zwecks Langlebigkeit und niedriger Servicekosten

*Le piston est caché à garantie de longue durée et bas coûts*

El pistón desaparece y garantiza una larga duración y bajos costos

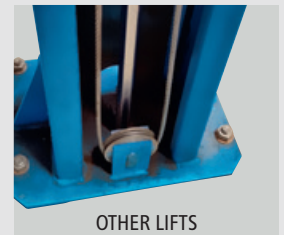

OTHER LIFTS

Puleggia esposta a sporco e colpi

*Pulley exposed to dirt and damages*

Riemenscheibe Schmutz und Schadensgefährdung ausgesetzt

*Poulie exposée à la poussière et à d'autres dommages*

Polea expuesta a posibles golpes y suciedad



OTHER LIFTS

Nessuna regolazione in altezza

*No adjustment possible*

Keine Einstellung möglich

*Pas de réglage possible*

Ninguna regulación posible



RAVAGLIOLI

Tampone extra basso ed estensibile in altezza

*Very low pad, adjustable height*

Sehr niedrige Gummiteiler in Höhe einstellbar

*Tampon extra bas, extensible en hauteur*

Taco extra-bajo y extensible en altura

Taco extra-bajo y extensible en altura

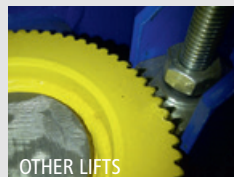

OTHER LIFTS

Quando i denti sono consumati il braccio scivola via

*When teeth are worn out, the arm can slide away*

Bei verschlissener Verzahnung rutschen die Arme weg

*Quand les dents sont usurés, le bras risque de glisser*

Cuando los dientes están desgastados el brazo puede deslizar

Cuando los dientes están desgastados el brazo puede deslizar



RAVAGLIOLI

Geometria conica con effetto autobloccante

*Self-locking conical design*

Konische Geometrie

*Géométrie conique autobloquante*

Geometria conica con efecto auto-bloqueador.

Geometria conica con efecto auto-bloqueador.



RAVAGLIOLI

Puleggia protetta all'interno della colonna

*Pulley protected inside the column*

Riemenscheibe in der Säule geschützt

*Poulie protégée à l'intérieur de la colonne*

Polea protegida al interior de la columna

Polea protegida al interior de la columna

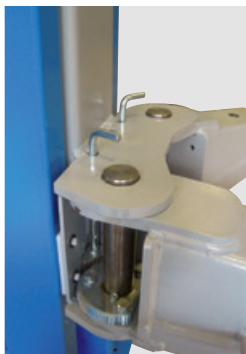

## QUALITY COMPONENTS

Carrello e bracci tagliati al laser - saldatura con robot.

*Laser cut carriages and arms - robot welding.*

Hubwagen und Arme mit Laser geschnitten - mit Roboter zusammengesweißt.

*Chariots et bras découpés au laser - soudage par robot.*

Carro y brazos cortados al laser - soldados por robot.



## EASY ADJUSTMENT

Funi facilmente registrabili.

*Easy to adjust cables.*

Seile leicht und schnell einstellbar.

*Réglage simple des câbles.*

Cables muy fáciles de registrar.

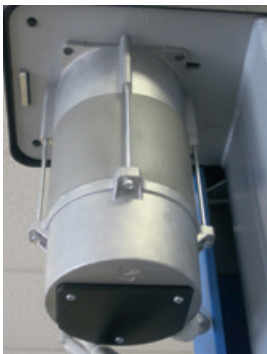

## HIGH EFFICIENCY MOTORS

Speciali motori ad alto rendimento per garantire potenza e durata nel tempo.

*Specially manufactured high efficiency motors.*

Spezielle Hochleistungsmotore garantieren Leistung und lange Lebensdauer.

*Moteurs spéciaux à hautes performances pour garantir puissance et durée dans le temps.*

*Motor especial de alto rendimiento para garantizar potencia y duración en el tiempo.*

rustehnika.ru

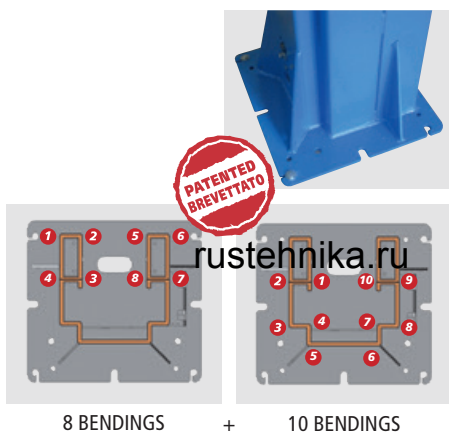

8 BENDINGS

+

10 BENDINGS

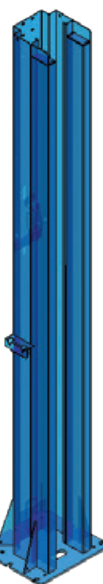

## EXTRA RESISTANT COLUMN DESIGN

Disegno esclusivo a 10+8 pieghe per la massima solidità.

*Exclusive 10+8 bending design to ensure max resistance to load.*

Exklusiv-Design 10+8 Faltungen für eine maximale Gewichtsresistenz.

*Le design exclusif 10+8 plis est garanti un support maxi de la charge.*

Diseño exclusivo con doblado 10+8 que garantiza la máxima solidez.

**MORE BENDINGS  
 =  
 MORE RESISTANCE**

## SPECIAL VERSION (→ VARKPH370.xx/T)

Versione a richiesta con:

- Comando singolo per salita/discesa
- Sgancio arresti pneumatico
- Centralina in alto.

*Version on demand featuring:*

- *Single lifting/lowering control*
- *Pneumatic release of locking devices*
- *Control unit on the upper part of the column.*

*Version auf Anfrage:*

- Drehwendschalter zum Hoch-und Runterfahren
- Pneumatische Entriegelung
- Hydraulikaggregat oben.

*Version sur demande avec:*

- *Commande unique pour montée-descente.*
- *Décrochage des arrêts pneumatiques.*
- *Unité hydraulique en haut.*

*Versión bajo pedido con:*

- Mando individual para bajada/subida
- Desenganche neumático de los trinquetes de seguridad de la cremallera mecánica
- Centralita posicionada en la parte alta de la columna.



## OPTION

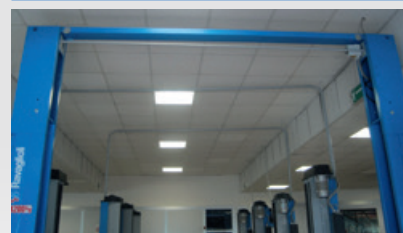

### S370A1T (→ VARKPH370.xx/T)

Fincorsa con azionamento a cavetto elastico

*Limit switch with elastic spring*

*Anschlagsicherheitsschalter mit Seil*

*Fin de course avec câble élastique*

Final de carrera con accionamiento tipo cable elástico



rustehnika.ru

rustehnika.ru

LIK VERSION

**KPH370.42K / 4200 kg**  
**KPH370.45KEX / 4500 kg (ALI)**

Bracci corti a tre stadi e bracci lunghi a due stadi per il sollevamento asimmetrico di furgoni e fuoristrada.

*Three-stage short arms and two-stage long arms provide asymmetric lifting of vans and off-road vehicles.*

Kurze Arme zweifach ausziehbar und lange Arme einmal ausziehbar zum asymmetrischen Heben von Gelände-und Lieferwagen.

*Bras courts à trois étages et bras longs à deux étages pour le chargement asymétrique de fourgons ou véhicules tout-terrain.*

Brazos cortos de tres extensiones y brazos largos de dos extensiones para el levantamiento asimétrico de furgonetas y todo terrenos.

**KPH370.42LIK / 4200 kg**  
**KPH370.45LIKEX / 4500 kg (ALI)**  
**KPH370.50LIK / 5000 kg**

Modello equipaggiato con 4 bracci lunghi a tre stadi: ideali per il sollevamento di furgoni e furgonati a passo lungo, consentono allo stesso tempo caricabilità ottimale anche per le autovetture.

*Model equipped with four long three-stage arms: ideal to lift long wheel base vans and easy loading of cars.*

Modell mit vier zweifach ausziehbaren langen Armen: ideal zum Heben von Lieferwagen auch mit langem Radstand, garantiert auch eine optimale Aufnahme von PKW.

*Élévateur équipé de quatre bras longs à trois étages: idéal pour le levage de fourgons à châssis long, il garantit aussi le levage optimal des voitures.*

Elevador equipado con 4 brazos largos de tres extensiones: ideal sea para el levantamiento de furgonetas normales y de chasis largo sea de turismos.

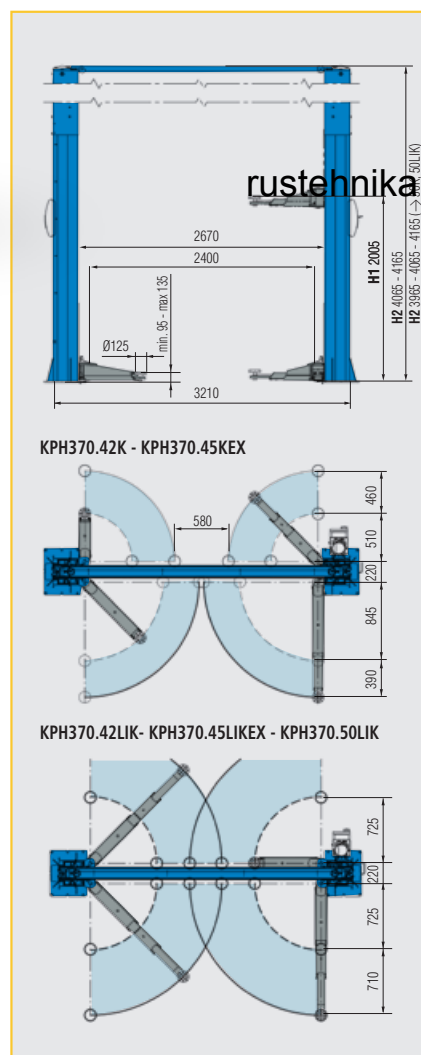

KPH370.42K - KPH370.45KEX

KPH370.42LIK - KPH370.45LIKEX - KPH370.50LIK



## OPTIONS

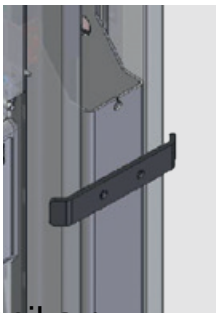

rustehnika.ru

### S370A5 (2 x kit)

Set parasportelli  
Set of door protections  
Satz Türanschläge  
Kit protection portes  
Juego de protecciones para puertas

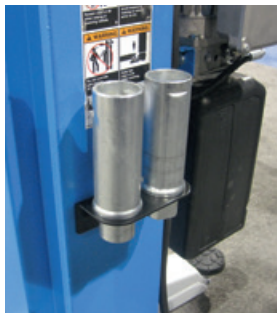

### S370A3 (2 x kit)

Kit supporto distanziali  
Spacer supports  
Satz Halterung Distanzhülsen  
Supports pour rehausses  
Soportes para espesores

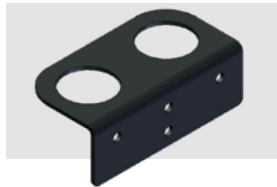

rustehnika.ru

### S370A20

Fincorsa con azionamento a barra  
Limit switch with bar  
Stangenbetätigter Endabschalter  
Fin de course avec barre d'actionnement  
Final de carrera con barra de accionamiento

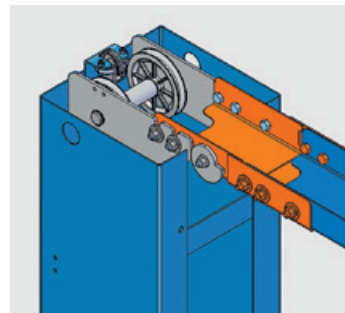

rustehnika.ru

### S370A4 (200 mm)

Estensione larghezza  
Width extension  
Verbreitung  
Extension en largeur  
Extensión de anchura

## OPTIONS → K, LIK, KEX, LIKEX

S224A3 (H=80mm)

S224A4 (H=140mm)

S370A18 (H=200mm)



4x



4x



4x

### For Fiat Ducato, Peugeot Boxer, Citroën Jumper

Distanziali / Spacers / Abstandstücke  
Rehausses / Espesores

## OPTIONS → S224A3, S224A4, S370A18

S370A19

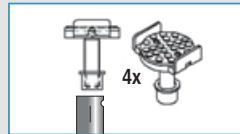

4x

Supporti presa telaio  
Frame adapters  
Halterungen für Chassisaufnahme  
Supports prise sur chassis  
Espesores de agarre sobre chasis

S370A17

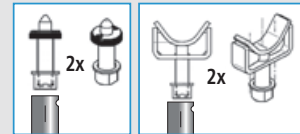

2x

### For Mercedes Sprinter, VW LT+Crafter

Supporti / Adapters /  
Halterungen / Supports  
Adaptadores de agarre



Ravaglioli S.p.A.

via 1° maggio 3  
Fraz. Pontecchio M.  
40037 Sasso Marconi (Bo) - Italia  
Tel. +39 - 051 - 6781511  
Fax +39 - 051 - 846349  
rav@ravaglioli.com  
www.ravaglioli.com

RAV France

4, Rue Longue Raie  
ZAC de la Tremblaié  
91220 Le Plessis Pâté  
Tel. 01.60.86.88.16  
Fax 01.60.86.82.04  
rav@ravfrance.fr

Ravaglioli Deutschland

Kirchenpoint 22  
85354 Freising  
Tel. 08165-646956  
Fax 08165-646958  
ravd@ravaglioli.com

RAV Equipment UK LTD

Prince Albert House  
20 King Street  
Maidenhead, SL6 1DT  
Tel. +39 - 0516781511  
rav@ravaglioli.com

RAV en Belgique

Nederlandstalig  
Tel. 0498-162016  
Fax 016-781025  
Zone Francophone  
Tel. 0498-163016  
Fax +32 78 055 030

RAV Equipos España S.L.U.

Avenida Europa 17  
Pol. Ind. de Constanti  
Tarragona 43120  
Tel. 977 524525  
Fax 977 524532  
ravequipos@ravaglioli.e.telefonica.net



DRD06U (14)

Le caratteristiche tecniche e gli allestimenti presentati in questo prospetto possono subire variazioni. Le immagini riprodotte non sono vincolanti.

Technical data and composition presented in this catalogue may vary. Pictures reproduced are only indicative.

Die techn. Daten und die Ausrüstungen, die in diesem Prospekt enthalten sind, können Änderungen erfahren. Deshalb sind die Abbildungen unverbindlich.

Les caractéristiques techniques et les compositions présentées dans ce prospectus peuvent subir des variations. Les images reproduites ont une valeur indicative.

Las características técnicas y las composiciones ilustradas en este folleto pueden sufrir variaciones. Las imágenes reproducidas no son vinculantes.

rustehnika.ru

rustehnika.ru

rustehnika.ru

